

Overview

The FY2 series is constructed of metallized polypropylene film encapsulated with self-extinguishing resin in a box of material meeting the requirement of UL94V-0.

Applications

Use in EMI filter in line-to-ground and line-by-pass applications requiring Y2 safety classification. Suitable for use in situations where failure of the capacitor would not lead to danger of electric shock.

Features

- High stability of capacitance
- High temperature (110°C)
- Self-healing property
- Over voltage stress withstanding
- Flame-retardant plastic case and resin

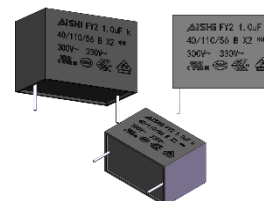

Marking

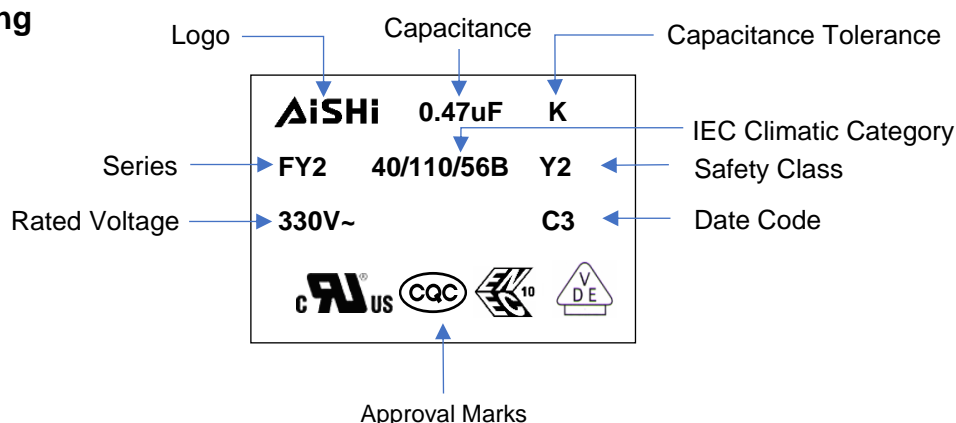

Manufacturing Date Code

Year	Code	Month	Code
2018	A	Jan	1
2019	B	Feb	2
2020	C	Mar	3
2021	D	Apr	4
2022	E	May	5
2023	F	Jun	6

Year	Code	Month	Code
2024	G	Jul	7
2025	H	Aug	8
2026	J	Sep	9
2027	K	Oct	A
2028	L	Nov	N
2029	M	Dec	D

Part Number System

F	Y2	30	K	474	G33	2GL	5
Capacitor Type	Series	Voltage (VAC)	Tolerance	Capacitance (pF)	Size Code	Terminal Code	Lead Length Code
F = Film	Class Y2, Metallized PP Film	300 330 350	J = ±5% K = ±10% M = ±20%	First two digits = significant figures. Third digit = Number of zeros.	Refer to Size Code Table	Refer to Terminal Code Table	Refer to Lead Length Table

Terminal Code

Digit One (Lead/Terminal Type)		Digit Two (Lead Space)		Digit Three (Lead Ipsilateral)	
2 leads for long	L	10.0mm	C	5.1mm	A
2 leads for straight cut	2	12.5mm	D	7.5mm	C
2 leads for forming cut	E	15.0mm	E	10.2mm	B
4 leads for straight cut	4	22.5mm	F	12.7mm	G
Taping	T	27.5mm	G	20.3mm	D
Taping Straight	V	37.5mm	K	N/A	L
		57.5mm	M		
		N/A	N		

Lead Length Code

Lead Length	
20mm min	L
35mm min	B
3.2mm	1
3.5mm	2
3.0mm	3
4.0mm	4
5.0mm	5
7.0mm	7
Taping	T
N/A	N

Dimension (mm)

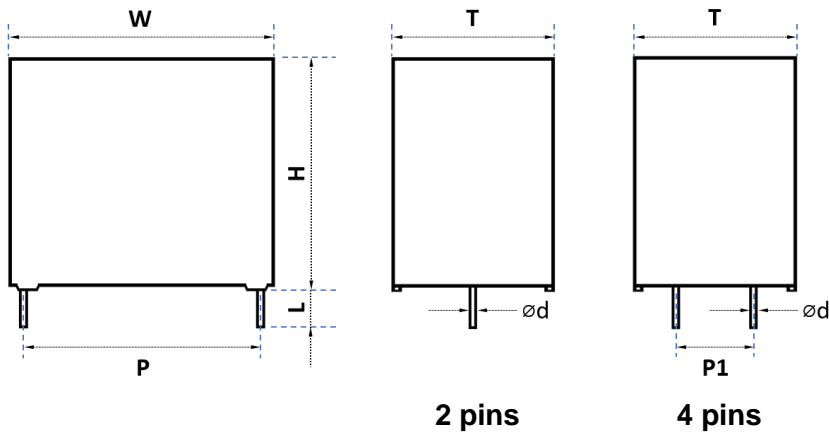

Size Code Table (mm)

Size Code	Dimension						Pitch		Lead Wire	
	W	Tolerance	H	Tolerance	T	Tolerance	P	Tolerance	Ød	Tolerance
B15	10.0	0.5	11.0	0.5	5.0	0.5	7.5	0.5	0.6	0.05
B16	10.0	0.5	12.0	0.5	6.0	0.5	7.5	0.5	0.6	0.05
C13	13.0	0.5	11.0	0.5	5.0	0.5	10.0	0.5	0.6	0.05
C16	13.0	0.5	12.0	0.5	6.0	0.5	10.0	0.5	0.6	0.05
E14	18.0	0.5	11.0	0.5	5.0	0.5	15.0	0.5	0.6	0.05
E17	18.0	0.5	12.0	0.5	6.0	0.5	15.0	0.5	0.6	0.05
E21	18.0	0.5	13.0	0.5	7.0	0.5	15.0	0.5	0.8	0.05
E29	18.0	0.5	13.5	0.5	7.5	0.5	15.0	0.5	0.8	0.05
E31	18.0	0.5	14.0	0.5	8.0	0.5	15.0	0.5	0.8	0.05
E34	18.0	0.5	14.5	0.5	8.5	0.5	15.0	0.5	0.8	0.05
E43	18.0	0.5	16.0	0.5	10.0	0.5	15.0	0.5	0.8	0.05
E45	18.0	0.5	18.0	0.5	10.0	0.5	15.0	0.5	0.8	0.05
E47	18.0	0.5	19.0	0.5	11.0	0.5	15.0	0.5	0.8	0.05
F14	26.0	0.5	15.5	0.5	6.0	0.5	22.5	0.5	0.6	0.05
F17	26.0	0.5	16.5	0.5	7.0	0.5	22.5	0.5	0.8	0.05
F20	26.0	0.5	17.0	0.5	8.5	0.5	22.5	0.5	0.8	0.05
F24	26.0	0.5	19.0	0.5	10.0	0.5	22.5	0.5	0.8	0.05
F26	26.0	0.5	20.0	0.5	11.0	0.5	22.5	0.5	0.8	0.05
F27	26.0	0.5	22.0	0.5	12.0	0.5	22.5	0.5	0.8	0.05
F30	26.0	0.5	24.5	0.5	13.0	0.5	22.5	0.5	0.8	0.05
F34	26.0	0.5	29.5	0.5	14.5	0.5	22.5	0.5	0.8	0.05
F36	26.0	0.5	25.0	0.5	15.0	0.5	22.5	0.5	0.8	0.05
F40	26.0	0.5	30.0	0.5	20.0	0.5	22.5	0.5	0.8	0.05
G15	32.0	0.8	18.0	0.8	9.0	0.8	27.5	0.5	0.8	0.05
G18	32.0	0.8	20.0	0.8	11.0	0.8	27.5	0.5	0.8	0.05
G21	32.0	0.8	22.0	0.8	13.0	0.8	27.5	0.5	0.8	0.05
G22	32.0	0.8	24.5	0.8	13.0	0.8	27.5	0.5	0.8	0.05

Size Code Table (mm)

Size Code	Dimension						Pitch		Lead Wire	
	W	Tolerance	H	Tolerance	T	Tolerance	P	Tolerance	Ød	Tolerance
G26	32.0	0.8	28.0	0.8	14.0	0.8	27.5	0.5	0.8	0.05
G27	32.0	0.8	24.5	0.8	15.0	0.8	27.5	0.5	0.8	0.05
G30	32.0	0.8	25.0	0.8	16.0	0.8	27.5	0.5	0.8	0.05
G33	32.0	0.8	28.0	0.8	18.0	0.8	27.5	0.5	0.8	0.05
G34	32.0	0.8	33.0	0.8	18.0	0.8	27.5	0.5	0.8	0.05
G37	32.0	0.8	31.0	0.8	21.0	0.8	27.5	0.5	0.8	0.05
G40	32.0	0.8	37.0	0.8	22.0	0.8	27.5	0.5	0.8	0.05
G50	32.0	0.8	32.0	0.8	16.0	0.8	27.5	0.5	0.8	0.05
G51	32.0	0.8	48.0	0.8	22.0	0.8	27.5	0.5	0.8	0.05
K10	42.5	0.8	22.0	0.8	11.0	0.8	37.5	0.5	1.0	0.05
K11	42.5	0.8	24.0	0.8	13.0	0.8	37.5	0.5	1.0	0.05
K12	42.5	0.8	24.0	0.8	15.0	0.8	37.5	0.5	1.0	0.05
K13	42.5	0.8	26.0	0.8	15.0	0.8	37.5	0.5	1.0	0.05
K14	42.5	0.8	30.0	0.8	16.0	0.8	37.5	0.5	1.0	0.05
K18	42.5	0.8	30.0	0.8	17.0	0.8	37.5	0.5	1.0	0.05
K20	42.5	0.8	28.0	0.8	19.0	0.8	37.5	0.5	1.0	0.05
K21	42.5	0.8	32.0	0.8	19.0	0.8	37.5	0.5	1.0	0.05
K24	42.5	0.8	40.0	0.8	20.0	0.8	37.5	0.5	1.0	0.05
K42	42.5	0.8	45.0	0.8	30.0	0.8	37.5	0.5	1.0	0.05

Rating and Part Number

Vac	Vdc	Cap Value μF	Dimensions				Peak Current A	Surge Current A	dv/dt V/us	Lead Wire mm	Part Number
			W mm	H mm	T mm	P mm					
300/330	1500	0.0047	13.0	11.0	5.0	10.0	2.35	7.05	500	0.6	FY230K472C132CL5
300/330	1500	0.0056	13.0	11.0	5.0	10.0	2.8	8.4	500	0.6	FY230K562C132CL5
300/330	1500	0.0068	13.0	11.0	5.0	10.0	3.4	10.2	500	0.6	FY230K682C132CL5
300/330	1500	0.0082	13.0	12.0	6.0	10.0	4.1	12.3	500	0.6	FY230K822C162CL5
300/330	1500	0.01	13.0	12.0	6.0	10.0	5	15	500	0.6	FY230K103C162CL5
300/330	1500	0.012	13.0	12.0	6.0	10.0	6	18	500	0.6	FY230K123C162CL5
300/330	1500	0.015	13.0	12.0	6.0	10.0	7.5	22.5	500	0.6	FY230K153C162CL5
300/330	1500	0.0047	18.0	11.0	5.0	15.0	1.88	5.64	400	0.6	FY230K472E142EL5
300/330	1500	0.0056	18.0	11.0	5.0	15.0	2.24	6.72	400	0.6	FY230K562E142EL5
300/330	1500	0.0068	18.0	11.0	5.0	15.0	2.72	8.16	400	0.6	FY230K682E142EL5
300/330	1500	0.0082	18.0	11.0	5.0	15.0	3.28	9.84	400	0.6	FY230K822E142EL5
300/330	1500	0.01	18.0	11.0	5.0	15.0	4	12	400	0.6	FY230K103E142EL5
300/330	1500	0.012	18.0	11.0	5.0	15.0	4.8	14.4	400	0.6	FY230K123E142EL5
300/330	1500	0.015	18.0	11.0	5.0	15.0	6	18	400	0.6	FY230K153E142EL5
300/330	1500	0.018	18.0	12.0	6.0	15.0	7.2	21.6	400	0.6	FY230K183E172EL5
300/330	1500	0.022	18.0	12.0	6.0	15.0	8.8	26.4	400	0.6	FY230K223E172EL5
300/330	1500	0.027	18.0	13.0	7.0	15.0	10.8	32.4	400	0.8	FY230K273E212EL5
300/330	1500	0.033	18.0	13.5	7.5	15.0	13.2	39.6	400	0.8	FY230K333E292EL5
300/330	1500	0.039	18.0	13.5	7.5	15.0	15.6	46.8	400	0.8	FY230K393E292EL5
300/330	1500	0.047	18.0	14.5	8.5	15.0	18.8	56.4	400	0.8	FY230K473E342EL5
300/330	1500	0.056	18.0	16.0	10.0	15.0	22.4	67.2	400	0.8	FY230K563E432EL5
300/330	1500	0.068	18.0	16.0	10.0	15.0	27.2	81.6	400	0.8	FY230K683E432EL5
300/330	1500	0.082	18.0	19.0	11.0	15.0	32.8	98.4	400	0.8	FY230K823E472EL5
300/330	1500	0.033	26.0	15.5	6.0	22.5	6.6	19.8	200	0.6	FY230K333F142FL5
300/330	1500	0.039	26.0	15.5	6.0	22.5	7.8	23.4	200	0.6	FY230K393F142FL5
300/330	1500	0.047	26.0	15.5	6.0	22.5	9.4	28.2	200	0.6	FY230K473F142FL5
300/330	1500	0.056	26.0	15.5	6.0	22.5	11.2	33.6	200	0.6	FY230K563F142FL5
300/330	1500	0.068	26.0	16.5	7.0	22.5	13.6	40.8	200	0.8	FY230K683F172FL5
300/330	1500	0.082	26.0	16.5	7.0	22.5	16.4	49.2	200	0.8	FY230K823F172FL5
300/330	1500	0.1	26.0	17.0	8.5	22.5	20	60	200	0.8	FY230K104F202FL5
300/330	1500	0.12	26.0	17.0	8.5	22.5	24	72	200	0.8	FY230K124F202FL5
300/330	1500	0.15	26.0	19.0	10.0	22.5	30	90	200	0.8	FY230K154F242FL5
300/330	1500	0.18	26.0	20.0	11.0	22.5	36	108	200	0.8	FY230K184F262FL5
300/330	1500	0.22	26.0	22.0	12.0	22.5	44	132	200	0.8	FY230K224F272FL5
300/330	1500	0.27	26.0	24.5	13.0	22.5	54	162	200	0.8	FY230K274F302FL5
300/330	1500	0.33	26.0	25.0	15.0	22.5	66	198	200	0.8	FY230K334F362FL5
300/330	1500	0.39	26.0	29.5	14.5	22.5	78	234	200	0.8	FY230K394F342FL5
300/330	1500	0.1	32.0	18.0	9.0	27.5	15	45	150	0.8	FY230K104G152GL5
300/330	1500	0.12	32.0	18.0	9.0	27.5	18	54	150	0.8	FY230K124G152GL5
300/330	1500	0.15	32.0	18.0	9.0	27.5	22.5	67.5	150	0.8	FY230K154G152GL5
300/330	1500	0.18	32.0	20.0	11.0	27.5	27	81	150	0.8	FY230K184G182GL5
300/330	1500	0.22	32.0	20.0	11.0	27.5	33	99	150	0.8	FY230K224G182GL5
300/330	1500	0.27	32.0	22.0	13.0	27.5	40.5	121.5	150	0.8	FY230K274G212GL5
300/330	1500	0.33	32.0	24.5	13.0	27.5	49.5	148.5	150	0.8	FY230K334G222GL5
300/330	1500	0.39	32.0	25.0	16.0	27.5	58.5	175.5	150	0.8	FY230K394G302GL5
300/330	1500	0.39	32.0	28.0	14.0	27.5	58.5	175.5	150	0.8	FY230K394G262GL5
300/330	1500	0.47	32.0	28.0	18.0	27.5	70.5	211.5	150	0.8	FY230K474G332GL5
300/330	1500	0.56	32.0	28.0	18.0	27.5	84	252	150	0.8	FY230K564G332GL5

Rating and Part Number

Vac	Vdc	Cap Value μF	Dimensions				Peak Current A	Surge Current A	dv/dt V/us	Lead Wire mm	Part Number
			W mm	H mm	T mm	P mm					
300/330	1500	0.68	32.0	33.0	18.0	27.5	102	306	150	0.8	FY230K684G342GL5
300/330	1500	0.82	32.0	37.0	22.0	27.5	123	369	150	0.8	FY230K824G402GL5
300/330	1500	1	32.0	37.0	22.0	27.5	150	450	150	0.8	FY230K105G402GL5
300/330	1500	0.33	42.5	22.0	11.0	37.5	33	99	100	1.0	FY230K334K102KL5
300/330	1500	0.39	42.5	24.0	13.0	37.5	39	117	100	1.0	FY230K394K112KL5
300/330	1500	0.47	42.5	24.0	13.0	37.5	47	141	100	1.0	FY230K474K112KL5
300/330	1500	0.56	42.5	26.0	15.0	37.5	56	168	100	1.0	FY230K564K132KL5
300/330	1500	0.68	42.5	30.0	17.0	37.5	68	204	100	1.0	FY230K684K182KL5
300/330	1500	0.82	42.5	30.0	17.0	37.5	82	246	100	1.0	FY230K824K182KL5
300/330	1500	0.82	42.5	28.0	19.0	37.5	82	246	100	1.0	FY230K824K202KL5
300/330	1500	1	42.5	32.0	19.0	37.5	100	300	100	1.0	FY230K105K212KL5
350	1500	0.0047	18.0	11.0	5.0	15.0	2.82	8.46	600	0.6	FY235K472E142EL5
350	1500	0.0056	18.0	11.0	5.0	15.0	3.36	10.08	600	0.6	FY235K562E142EL5
350	1500	0.0068	18.0	11.0	5.0	15.0	4.08	12.24	600	0.6	FY235K682E142EL5
350	1500	0.0082	18.0	11.0	5.0	15.0	4.92	14.76	600	0.6	FY235K822E142EL5
350	1500	0.01	18.0	11.0	5.0	15.0	6	18	600	0.6	FY235K103E142EL5
350	1500	0.012	18.0	12.0	6.0	15.0	7.2	21.6	600	0.8	FY235K123E172EL5
350	1500	0.015	18.0	12.0	6.0	15.0	9	27	600	0.8	FY235K153E172EL5
350	1500	0.018	18.0	13.0	7.0	15.0	10.8	32.4	600	0.8	FY235K183E212EL5
350	1500	0.022	18.0	13.0	7.0	15.0	13.2	39.6	600	0.8	FY235K223E212EL5
350	1500	0.027	18.0	14.0	8.0	15.0	16.2	48.6	600	0.8	FY235K273E312EL5
350	1500	0.033	18.0	14.0	8.0	15.0	19.8	59.4	600	0.8	FY235K333E312EL5
350	1500	0.039	18.0	14.5	8.5	15.0	23.4	70.2	600	0.8	FY235K393E342EL5
350	1500	0.039	18.0	16.0	10.0	15.0	23.4	70.2	600	0.8	FY235K393E432EL5
350	1500	0.047	18.0	16.0	10.0	15.0	28.2	84.6	600	0.8	FY235K473E432EL5
350	1500	0.056	18.0	18.0	10.0	15.0	33.6	100.8	600	0.8	FY235K563E452EL5
350	1500	0.056	18.0	19.0	11.0	15.0	33.6	100.8	600	0.8	FY235K563E472EL5
350	1500	0.068	18.0	19.0	11.0	15.0	40.8	122.4	600	0.8	FY235K683E472EL5
350	1500	0.033	26.0	15.5	6.0	22.5	16.5	49.5	500	0.8	FY235K333F142FL5
350	1500	0.039	26.0	15.5	6.0	22.5	19.5	58.5	500	0.8	FY235K393F142FL5
350	1500	0.047	26.0	16.5	7.0	22.5	23.5	70.5	500	0.8	FY235K473F172FL5
350	1500	0.056	26.0	16.5	7.0	22.5	28	84	500	0.8	FY235K563F172FL5
350	1500	0.068	26.0	17.0	8.5	22.5	34	102	500	0.8	FY235K683F202FL5
350	1500	0.082	26.0	17.0	8.5	22.5	41	123	500	0.8	FY235K823F202FL5
350	1500	0.082	26.0	19.0	10.0	22.5	41	123	500	0.8	FY235K823F242FL5
350	1500	0.1	26.0	19.0	10.0	22.5	50	150	500	0.8	FY235K104F242FL5
350	1500	0.12	26.0	19.0	10.0	22.5	60	180	500	0.8	FY235K124F242FL5
350	1500	0.12	26.0	20.0	11.0	22.5	60	180	500	0.8	FY235K124F262FL5
350	1500	0.15	26.0	20.0	11.0	22.5	75	225	500	0.8	FY235K154F262FL5
350	1500	0.15	26.0	22.0	12.0	22.5	75	225	500	0.8	FY235K154F272FL5
350	1500	0.18	26.0	24.5	13.0	22.5	90	270	500	0.8	FY235K184F302FL5
350	1500	0.18	26.0	29.5	14.5	22.5	90	270	500	0.8	FY235K184F342FL5
350	1500	0.22	26.0	29.5	14.5	22.5	110	330	500	0.8	FY235K224F342FL5
350	1500	0.27	26.0	29.5	14.5	22.5	135	405	500	0.8	FY235K274F342FL5
350	1500	0.33	26.0	30.0	20.0	22.5	165	495	500	0.8	FY235K334F402FL5
350	1500	0.39	26.0	30.0	20.0	22.5	195	585	500	0.8	FY235K394F402FL5
350	1500	0.1	32.0	20.0	11.0	27.5	40	120	400	0.8	FY235K104G182GL5
350	1500	0.12	32.0	20.0	11.0	27.5	48	144	400	0.8	FY235K124G182GL5

Rating and Part Number

Vac	Vdc	Cap Value μF	Dimensions				Peak Current A	Surge Current A	dv/dt V/us	Lead Wire mm	Part Number
			W mm	H mm	T mm	P mm					
350	1500	0.15	32.0	20.0	11.0	27.5	60	180	400	0.8	FY235K154G182GL5
350	1500	0.15	32.0	22.0	13.0	27.5	60	180	400	0.8	FY235K154G212GL5
350	1500	0.18	32.0	22.0	13.0	27.5	72	216	400	0.8	FY235K184G212GL5
350	1500	0.22	32.0	24.5	13.0	27.5	88	264	400	0.8	FY235K224G222GL5
350	1500	0.27	32.0	24.5	15.0	27.5	108	324	400	0.8	FY235K274G272GL5
350	1500	0.33	32.0	32.0	16.0	27.5	132	396	400	0.8	FY235K334G502GL5
350	1500	0.33	32.0	28.0	18.0	27.5	132	396	400	0.8	FY235K334G332GL5
350	1500	0.39	32.0	32.0	16.0	27.5	156	468	400	0.8	FY235K394G502GL5
350	1500	0.39	32.0	28.0	18.0	27.5	156	468	400	0.8	FY235K394G332GL5
350	1500	0.47	32.0	32.0	16.0	27.5	188	564	400	0.8	FY235K474G502GL5
350	1500	0.47	32.0	33.0	18.0	27.5	188	564	400	0.8	FY235K474G342GL5
350	1500	0.56	32.0	31.0	21.0	27.5	224	672	400	0.8	FY235K564G372GL5
350	1500	0.68	32.0	37.0	22.0	27.5	272	816	400	0.8	FY235K684G402GL5
350	1500	0.82	32.0	48.0	22.0	27.5	328	984	400	0.8	FY235K824G512GL5
350	1500	1	32.0	48.0	22.0	27.5	400	1200	400	0.8	FY235K105G512GL5
350	1500	0.27	42.5	22.0	12.0	37.5	81	243	300	1.0	FY235K274K102KL5
350	1500	0.33	42.5	24.0	15.0	37.5	99	297	300	1.0	FY235K334K122KL5
350	1500	0.39	42.5	24.0	15.0	37.5	117	351	300	1.0	FY235K394K122KL5
350	1500	0.47	42.5	30.0	16.0	37.5	141	423	300	1.0	FY235K474K142KL5
350	1500	0.56	42.5	30.0	16.0	37.5	168	504	300	1.0	FY235K564K142KL5
350	1500	0.68	42.5	32.0	19.0	37.5	204	612	300	1.0	FY235K684K212KL5
350	1500	0.82	42.5	32.0	19.0	37.5	246	738	300	1.0	FY235K824K212KL5
350	1500	0.82	42.5	40.0	20.0	37.5	246	738	300	1.0	FY235K824K242KL5
350	1500	1	42.5	40.0	20.0	37.5	300	900	300	1.0	FY235K105K242KL5
350	1500	1.2	42.5	45.0	30.0	37.5	360	1080	300	1.0	FY235K125K422KL5

General Technical Data

Application	Line-to-ground / Line-by-pass (Class Y2)
Dielectric	Metallized Polypropylene Film
Reference Standard	IEC 60384-14; UL 60384-14; GB/T 6346.14-2015
Climatic Category	40/110/56 IEC60068-1
Passive Flammability Class	B
Operating Temperature Range	-40°C ~ +110°C (85°C ~110°C, decreasing factor 1.25% per °C for Urms)
Protection	Solvent resistant plastic case UL94 V-0 Thermosetting resin sealing UL 94 V-0 compliant
Installation	Any position
Packaging	Packed in cardboard boxes with protection for the terminals
Storage Conditions	Storage time: ≤ 24 months from the date marked on the label package Temperature and relative humidity should be -10°C ~ +40°C and not more than 75%RH. RH ≤ 85% for 30 days randomly distributed throughout the year
RoHS Compliant	Compliant with the restricted substance requirements of Directive 2011/65/EU
Flame Retardant Grade	Flame retardant performance accords with horizontal combustion grade HB and vertical combustion grade V-0.

Construction

Metallized Film	OPP & Al/Zn
Metal Sprayed	Sn/Zn Alloy
Connection Electrode	Copper clad steel wire or Tinned copper wires
Plastic Case	Plastic Case (UL94V-0)
Filling	Epoxy Resin (UL94V-0)
Film Construction	Internal Series Connection 

Electrical Characteristics

Voltage Range	300Vac ~ 350Vac 50/60Hz
Capacitance Range	0.0047 μ F to 1.2 μ F
Capacitance Tolerance	\pm 10% or \pm 20% at +25°C
Capacitance	Measuring Frequency at 1kHz Measuring Voltage: 1 ± 0.2 V
Standard Atmospheric Conditions for Static Test	Ambient temperature 15°C to 35°C (If there is any doubt on the results, the measurements shall be made at +20 +/- 5°C) Relative humidity 45% to 75% (If there is any doubt on the results, the measurements shall be made at 60% to 70 %.) Air pressure 86 kPa to 106 kPa.
Voltage Between Terminals U_{TT}	AC Voltage: $U_R + 1200$ Vac for 60 seconds or $2U_R + 1200$ Vac for 2 seconds DC Voltage: 4000VDC for 2 seconds, charge current must be 1A maximum Withstanding (DC) voltage (cut off current 10mA), rise time 100V/S.
Voltage Between Terminals and Case U_{TC}	2200Vac, 60 seconds (at +20 +/- 2°C)
Dielectric Dissipation Factor $Tg\delta_0$	$\leq 2 \times 10^{-4}$
Dissipation Factor	0.0020 (0.2%) at 20°C, 1KHz
Insulation Resistance	R between leads, for $C \leq 0.33 \mu F$ at 100 V; 1 min > 15 000 M Ω RC between leads, for $C > 0.33 \mu F$ at 100 V; 1 min > 5000 M $\Omega \cdot \mu F$
Hot-Spot	$\leq 85^\circ C$
Life Expectancy	100 000hours (U_R , $\Theta_{hotspot} = 85^\circ C$)
Failure Rate	100 Fit
Max. Altitude	2000 m

Characteristics Curve

Maximum Current (I_{rms}) Vs Frequency

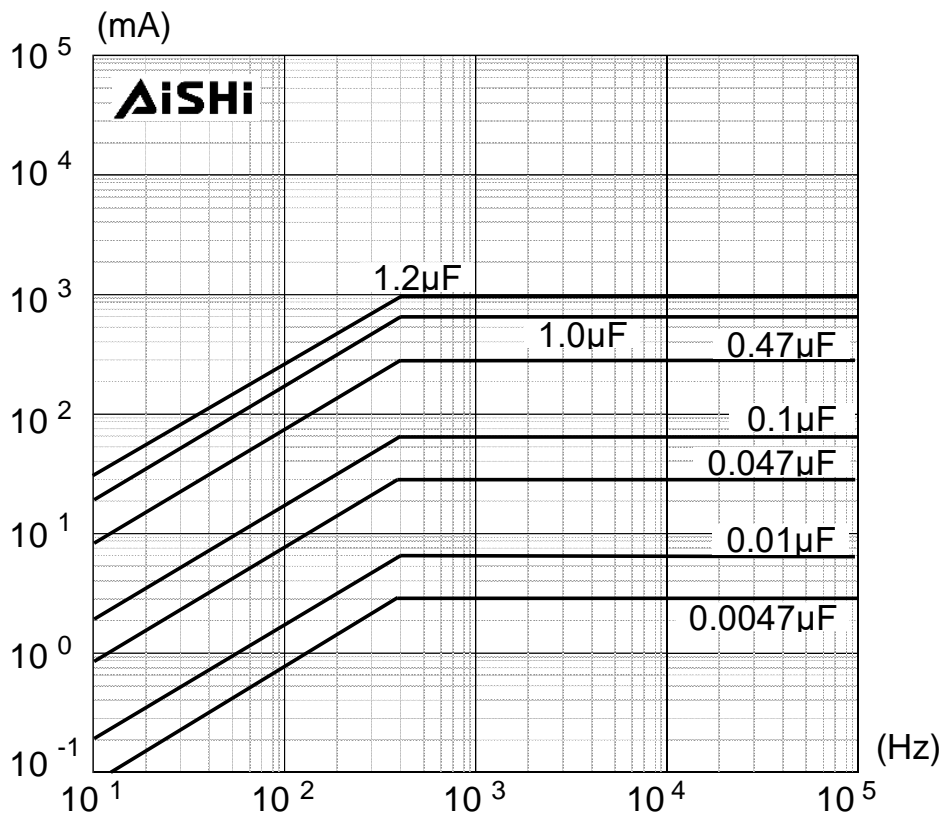

Resonant VS Capacitance

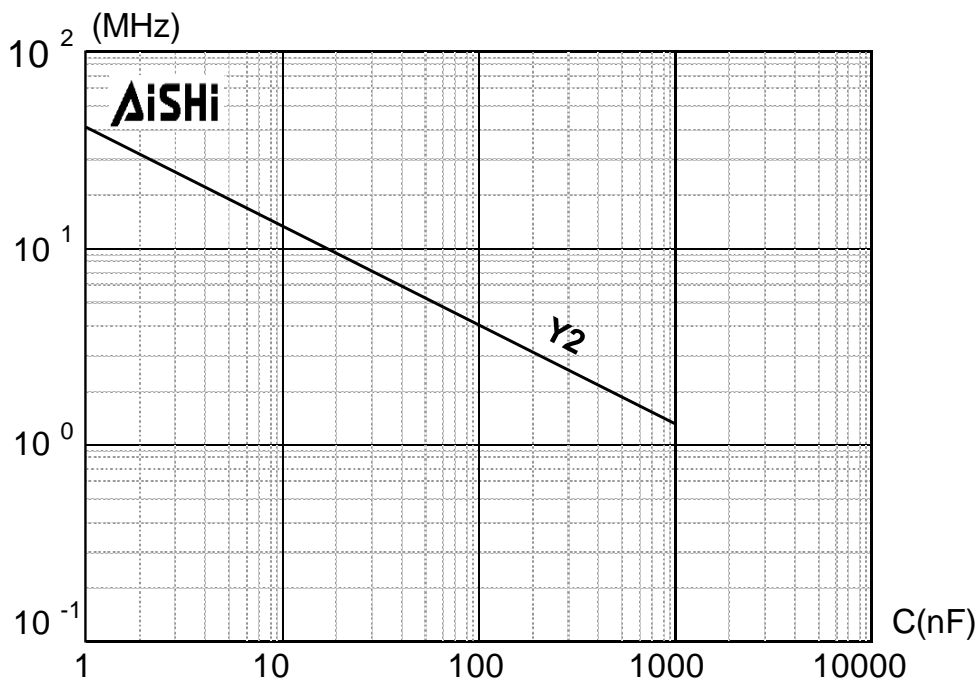

Characteristics Curve

Maximum Voltage (V_{rms}) Versus Frequency

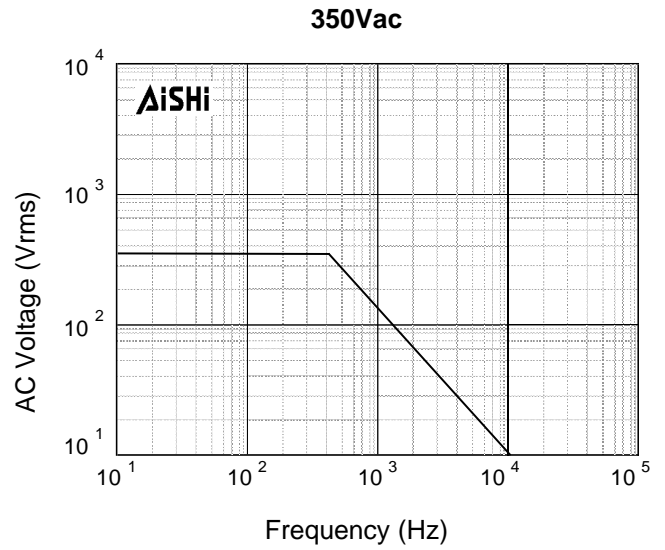
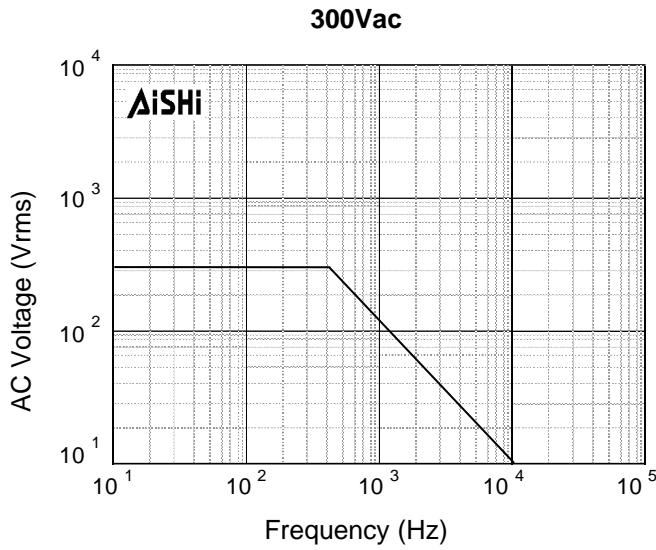

Expected Life Curve

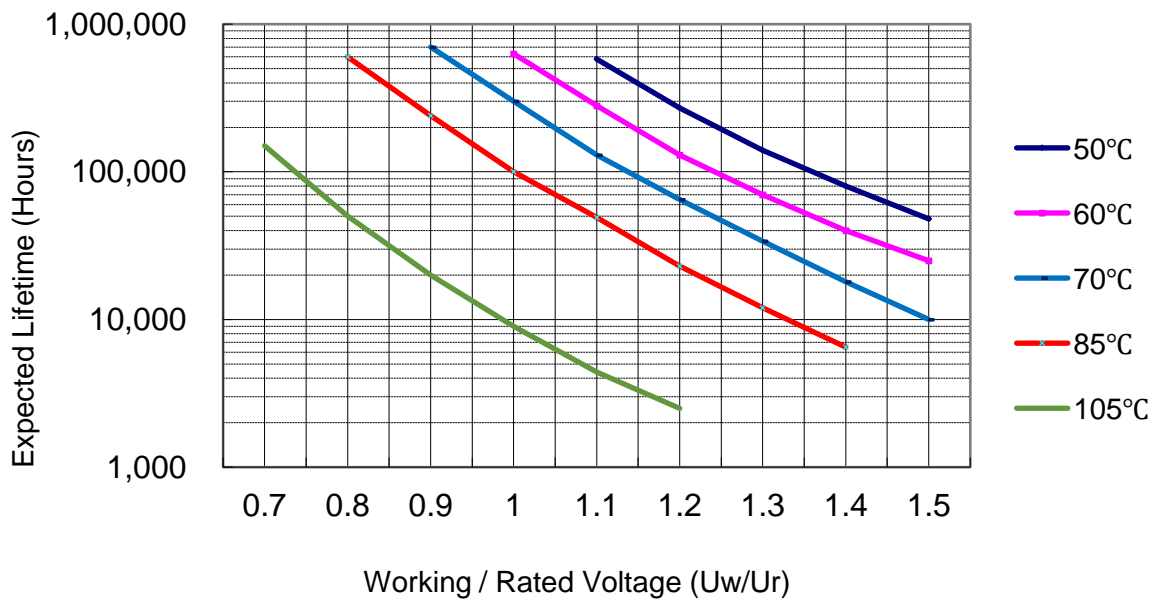

Derating of Rated Voltage Vs Temperature

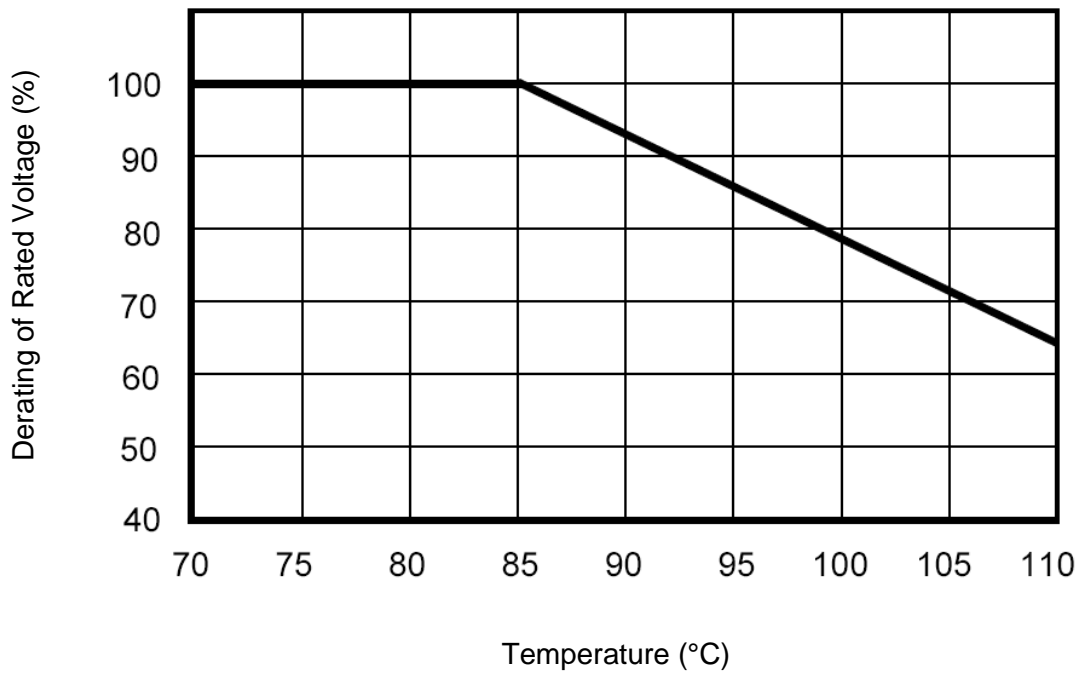

Wave Soldering Recommendations

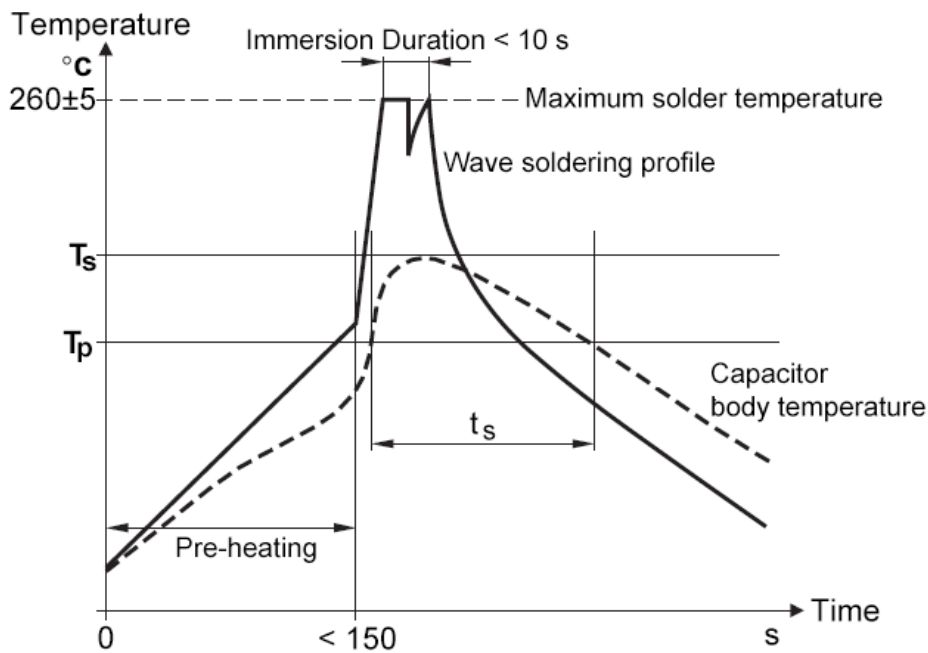

Ts: Capacitor body maximum temperature at wave soldering
 Tp: Capacitor body maximum temperature at pre-heating

Polypropylene Capacitors	Polyester Capacitors
During pre-heating: $T_p \leq 110^\circ\text{C}$ During soldering: $T_s \leq 120^\circ\text{C}$, $t_s \leq 60$	During pre-heating: $T_p \leq 130^\circ\text{C}$ During soldering: $T_s \leq 160^\circ\text{C}$, $t_s \leq 60\text{s}$

Packaging Information

Inner Box Specifications (Dimensions)			
Box #	L ±3mm	W±3mm	H ±3mm
# 1	331	331	25
# 2	331	331	35
# 3	331	331	50
# 4	331	331	80
# 5	350	170	35
# 6	350	170	50
# 7	350	170	80

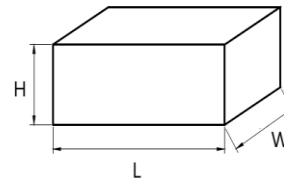

Outer Box Specifications (Dimensions)			
Box #	L ±5mm	W±5mm	H ±5mm
# 1	350	340	265
# 2	370	360	350

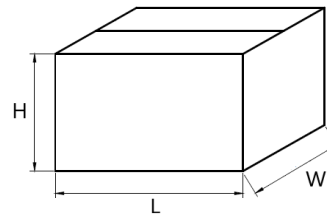

Packaging Quantity

P	Code	W	H	T	Long Leads	Short Leads	Ammo
10.0	C13	13.0	11.0	5.0	1200	1426	600
	C16	13.0	12.0	6.0	1200	1173	500
	C26	13.0	14.0	8.0	1200	874	370
15.0	E17	18.0	12.0	6.0	800	867	500
	E21	18.0	13.0	7.0	800	748	420
	E34	18.0	14.5	8.5	600	612	350
	E43	18.0	16.0	10.0	600	527	300
	E47	18.0	19.0	11.0	600	476	270
	E52	18.0	22.0	12.5	600	408	240
22.5	F17	26.0	16.5	7.0	600	528	252
	F20	26.0	17.0	8.5	600	432	210
	F24	26.0	19.0	10.0	400	372	180
	F26	26.0	20.0	11.0	400	336	162
	F27	26.0	22.0	12.0	400	300	150
	F29	26.0	23.0	13.0	400	276	138
	F32	26.0	24.0	14.0	400	264	126
	F36	26.0	25.0	15.0	400	240	120
27.5	G18	32.0	20.0	11.0	200	252	162
	G21	32.0	22.0	13.0	200	207	138
	G22	32.0	24.5	13.0	200	207	138
	G26	32.0	28.0	14.0	200	198	126
	G34	32.0	33.0	18.0	100	153	96
	G40	32.0	37.0	22.0	100	126	78
37.5	K21	42.5	32.0	19.0		112	
	K32	42.5	44.0	24.0		91	
	K42	42.5	45.0	30.0		70	
52.5	M16	57.5	45.0	30.0		50	

Lead Taping Information

Taping Style: Straight leads

Lead spacing: 10 - 15mm

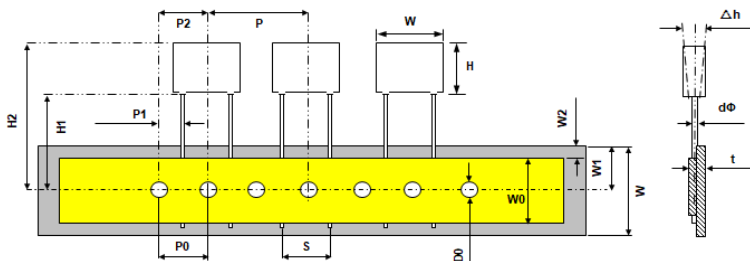

Quantity: 10pcs / line

Lead spacing: 22.5 – 27.5mm

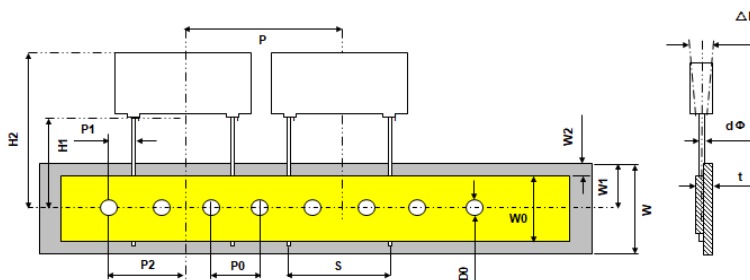

Quantity: 6pcs / line

Taping Specification

Description	Symbol	Dimension (mm)				Tolerance
Lead Spacing	S	10.0	12.5	15.0	22.5	+0.8/-0.2
Taping Pitch	P	25.4	25.4	25.4	38.0	±1.0
Feed Hole Pitch	P0	12.7	12.7	12.7	12.7	±0.2
Centering of Lead Wire	P1	7.7	6.5	5.2	7.80	±0.7
Centering of Body	P2	12.7	12.7	12.7	19.1	±1.3
Carrier Tape Width	W	18.0	18.0	18.0	18.0	±0.5
Hold Down Tape Width	W0	9.5	9.5	9.5	9.5	minimum
Hole Position	W1	9.0	9.0	9.0	9.0	±0.5
Hold Down Tape Position	W2	3.0	3.0	3.0	3.0	maximum
Feed Hole Diameter	D0	4.0	4.0	4.0	4.0	±0.2
Height of Component From Tape Center	H1	20.0	20.0	20.0	20.0	±0.5
Top Edge of Component	H2	39.0	39.0	39.0	44.0	maximum
Lead Wire Diameter	d	0.6	0.8	0.8	0.8	±0.1
Component Alignment	Δh	0.0	0.0	0.0	0.0	±2.0
Tape Thickness	t	0.7	0.7	0.7	0.7	±0.2

Cautions and Warnings

- Don't exceed the upper category temperature.
- For longtime storage, maximum relative humidity 80%, no dew allowed on the capacitor.
- Do not use or store capacitor in corrosive atmosphere, in the dusty environment's regular maintenance and cleaning especially of the terminals is required to avoid conductive path between terminal / or terminal and ground.
- Don't apply any mechanical stress to the capacitor terminals, and avoid any compressive, tensile or flexural stress.
- Don't move the capacitor after fixed to the PC board, and don't pick up the PC board by the fixed capacitor.
- Don't place the capacitor on a PC board whose holes space differs from the specified space.
- Avoid overload of the capacitors
- Do not have unlimited service life expectancy, the max service life expectancy may vary depending on the application the capacitor is used in.

Disclaimer

All product, product specifications and data in this datasheet are subject to change without notice to improve reliability, function or design or otherwise. The customer is responsible for checking and verifying the extent to which the Information contained in this publication is applicable to an order at the time the order is placed. All Information given herein is believed to be accurate and reliable, but it is presented without guarantee, warranty, or responsibility of any kind, expressed or implied.

In individual cases, a malfunction of electronic components or failure before the end of their usual service life cannot be completely ruled out in the current state of the art, even if they are operated as specified. In customer application requiring a very high level of operational safety and especially in customer applications in which the malfunction or failure of an electronic component could endanger human life or health (e.g. in accident prevention or lifesaving systems), it must therefore be ensured by means of suitable design of the customer application or other action taken by the customer (e.g. installation of protective circuitry or redundancy) that no injury or damage is sustained by third parties in the event of malfunction or failure of an electronic component.

We continue efforts to improve our products. Therefore, the products described in this publication may change from time to time. The same is true of the corresponding product specifications. Please check therefore to what extent product descriptions and specifications contained in this publication are still applicable before or when you place an order. We also reserve the right to discontinue production and delivery of products. Consequently, we cannot guarantee that all products named in this publication will always be available.

No license, express or implied, by estoppel or otherwise, to any intellectual property rights is granted by this document or by any conduct of Aishi. Product names and markings noted herein may be trademarks of their respective owners.