

### Overview

The FXQ capacitor is constructed of Metallized Polypropylene Film encapsulated with self-extinguishing resin in plastic box of material meeting the UL 94V-0 requirements. The series are suitable for harsh environment, qualify in accordance to AEC-Q200 requirement.

### Applications

Interference suppression, across-the-line capacitor, EMI filter and spark-killer in class X2 applications. Suitable for use in situations where failure of the capacitor would not lead to danger of electric shock.

### Features

- High stability of capacitance
- High temperature (110°C)
- Self-healing property
- Over voltage stress withstanding
- Flame-retardant plastic case and resin
- Suitable for harsh environment conditions
- Automotive Grade (AEC-Q200D)

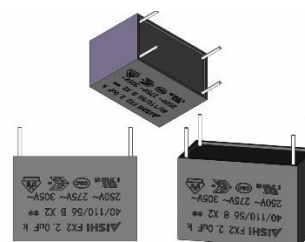

### Approvals

Marking	Standard	File Number
	UL 60384-14 and, CAN/CSA-E60384-14	E500538
	EN/IEC 60384-14	40051583
	IEC 60384-14, GB/T6346.14-2015	CQC20001245437

### Marking

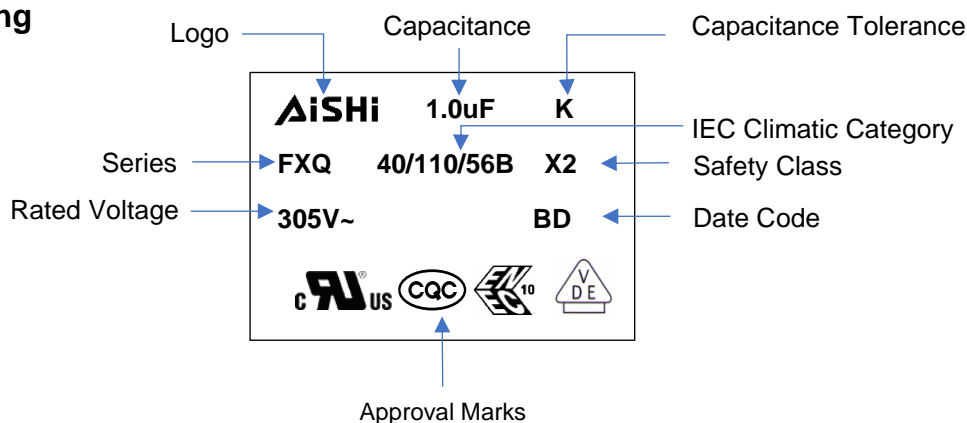

### Manufacturing Date Code

Year	Code	Month	Code
2018	A	Jan	1
2019	B	Feb	2
2020	C	Mar	3
2021	D	Apr	4
2022	E	May	5
2023	F	Jun	6

Year	Code	Month	Code
2024	G	Jul	7
2025	H	Aug	8
2026	J	Sep	9
2027	K	Oct	A
2028	L	Nov	N
2029	M	Dec	D

### Part Number System

F	XQ	30	K	105	G18	2GL	5
Capacitor Type	Series	Voltage (VAC)	Tolerance	Capacitance (pF)	Size Code	Terminal Code	Lead Length Code
F = Film	X2, AEC-Q200 Type, Metallized PP Film	305	J = ±5% K = ±10% M = ±20%	First two digits = significant figures. Third digit = Number of zeros.	Refer to Dimension Table	Refer to Terminal Code Table	Refer to Lead Length Table

### Terminal Code

Digit One (Lead/Terminal Type)		Digit Two (Lead Space)		Digit Three (Lead Ipsilateral)	
2 leads for long	L	10.0mm	C	5.1mm	A
2 leads for straight cut	2	12.5mm	D	7.5mm	C
2 leads for forming cut	E	15.0mm	E	10.2mm	B
4 leads for straight cut	4	22.5mm	F	12.7mm	G
Taping	T	27.5mm	G	20.3mm	D
Taping Straight	V	37.5mm	K	N/A	L
		57.5mm	M		
		N/A	N		

### Lead Length Code

Lead Length	
20mm min	L
35mm min	B
3.2mm	1
3.5mm	2
3.0mm	3
4.0mm	4
5.0mm	5
7.0mm	7
Taping	T
N/A	N

**Dimension (mm)**

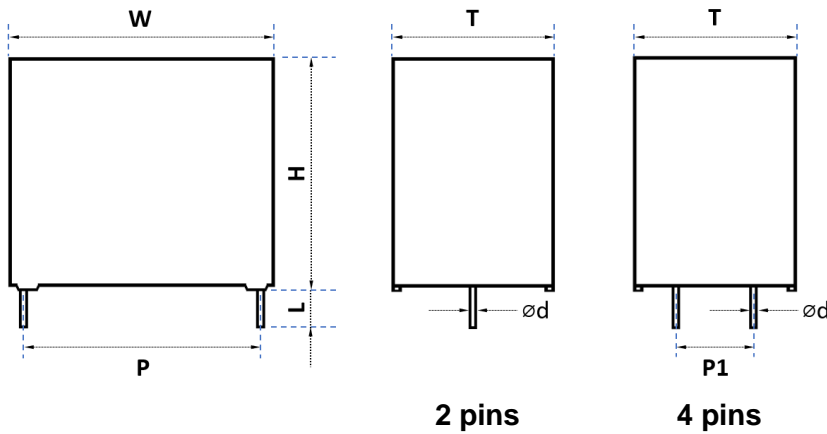

**Size Code Table (mm)**

Size Code	Dimension						Pitch				Lead Wire	
	W	Tolerance	H	Tolerance	T	Tolerance	P	Tolerance	P1	Tolerance	Ød	Tolerance
C13	13.0	0.5	11.0	0.5	5.0	0.5	10.0	0.5	\	\	0.6	0.05
C16	13.0	0.5	12.0	0.5	6.0	0.5	10.0	0.5	\	\	0.6	0.05
C26	13.0	0.5	14.0	0.5	8.0	0.5	10.0	0.5	\	\	0.6	0.05
E17	18.0	0.5	12.0	0.5	6.0	0.5	15.0	0.5	\	\	0.6	0.05
E21	18.0	0.5	13.0	0.5	7.0	0.5	15.0	0.5	\	\	0.6	0.05
E34	18.0	0.5	14.5	0.5	8.5	0.5	15.0	0.5	\	\	0.8	0.05
E43	18.0	0.5	16.0	0.5	10.0	0.5	15.0	0.5	\	\	0.8	0.05
E47	18.0	0.5	19.0	0.5	11.0	0.5	15.0	0.5	\	\	0.8	0.05
E52	18.0	0.5	22.0	0.5	12.5	0.5	15.0	0.5	\	\	0.8	0.05
F17	26.0	0.5	16.5	0.5	7.0	0.5	22.5	0.5	\	\	0.8	0.05
F20	26.0	0.5	17.0	0.5	8.5	0.5	22.5	0.5	\	\	0.8	0.05
F24	26.0	0.5	19.0	0.5	10.0	0.5	22.5	0.5	\	\	0.8	0.05
F26	26.0	0.5	20.0	0.5	11.0	0.5	22.5	0.5	\	\	0.8	0.05
F27	26.0	0.5	22.0	0.5	12.0	0.5	22.5	0.5	\	\	0.8	0.05
F29	26.0	0.5	23.0	0.5	13.0	0.5	22.5	0.5	\	\	0.8	0.05
F32	26.0	0.5	24.0	0.5	14.0	0.5	22.5	0.5	\	\	0.8	0.05
F36	26.0	0.5	25.0	0.5	15.0	0.5	22.5	0.5	\	\	0.8	0.05
G18	32.0	0.8	20.0	0.8	11.0	0.8	27.5	0.5	\	\	0.8	0.05
G21	32.0	0.8	22.0	0.8	13.0	0.8	27.5	0.5	\	\	0.8	0.05
G22	32.0	0.8	24.5	0.8	13.0	0.8	27.5	0.5	\	\	0.8	0.05
G26	32.0	0.8	28.0	0.8	14.0	0.8	27.5	0.5	\	\	0.8	0.05
G34	32.0	0.8	33.0	0.8	18.0	0.8	27.5	0.5	\	\	0.8	0.05
G40	32.0	0.8	37.0	0.8	22.0	0.8	27.5	0.5	10.2	0.5	1.2	0.05
K21	42.5	0.8	32.0	0.8	19.0	0.8	37.5	0.5	10.2	0.5	1.2	0.05
K32	42.5	0.8	44.0	0.8	24.0	0.8	37.5	0.5	10.2	0.5	1.2	0.05
K42	42.5	0.8	45.0	0.8	30.0	0.8	37.5	0.5	20.3	0.5	1.2	0.05
M16	57.5	1.0	45.0	1.0	30.0	1.0	52.5	0.5	20.3	0.5	1.2	0.05

**Rating and Part Number**

Vac	Vdc	Cap Value μF	Dimensions					Peak Current A	Surge Current A	dv/dt V/us	Lead Wire mm	Part Number
			w mm	H mm	T mm	P mm	P1 mm					
305	630	0.1	18.0	12.0	6.0	15.0	\	40	120	400	0.6	FXQ30K104E172EL5
305	630	0.15	18.0	12.0	6.0	15.0	\	60	180	400	0.6	FXQ30K154E172EL5
305	630	0.15	18.0	13.0	7.0	15.0	\	60	180	400	0.6	FXQ30K154E212EL5
305	630	0.22	18.0	14.5	8.5	15.0	\	88	264	400	0.8	FXQ30K224E342EL5
305	630	0.27	18.0	14.5	8.5	15.0	\	108	324	400	0.8	FXQ30K274E342EL5
305	630	0.33	18.0	16.0	10.0	15.0	\	132	396	400	0.8	FXQ30K334E432EL5
305	630	0.47	18.0	19.0	11.0	15.0	\	188	564	400	0.8	FXQ30K474E472EL5
305	630	0.56	18.0	19.0	11.0	15.0	\	224	672	400	0.8	FXQ30K564E472EL5
305	630	0.68	18.0	22.0	12.5	15.0	\	272	816	400	0.8	FXQ30K684E522EL5
305	630	0.82	18.0	22.0	12.5	15.0	\	328	984	400	0.8	FXQ30K824E522EL5
305	630	0.22	26.0	16.5	7.0	22.5	\	44	132	200	0.8	FXQ30K224F172FL5
305	630	0.27	26.0	16.5	7.0	22.5	\	54	162	200	0.8	FXQ30K274F172FL5
305	630	0.33	26.0	17.0	8.5	22.5	\	66	198	200	0.8	FXQ30K334F202FL5
305	630	0.47	26.0	19.0	10.0	22.5	\	94	282	200	0.8	FXQ30K474F242FL5
305	630	0.56	26.0	19.0	10.0	22.5	\	112	336	200	0.8	FXQ30K564F242FL5
305	630	0.68	26.0	20.0	11.0	22.5	\	136	408	200	0.8	FXQ30K684F262FL5
305	630	0.82	26.0	20.0	11.0	22.5	\	164	492	200	0.8	FXQ30K824F262FL5
305	630	1.0	26.0	22.0	12.0	22.5	\	200	600	200	0.8	FXQ30K105F272FL5
305	630	1.2	26.0	23.0	13.0	22.5	\	240	720	200	0.8	FXQ30K125F292FL5
305	630	1.5	26.0	24.0	14.0	22.5	\	300	900	200	0.8	FXQ30K155F322FL5
305	630	1.5	26.0	25.0	15.0	22.5	\	300	900	200	0.8	FXQ30K155F362FL5
305	630	1.0	32.0	20.0	11.0	27.5	\	150	450	150	0.8	FXQ30K105G182GL5
305	630	1.2	32.0	22.0	13.0	27.5	\	180	540	150	0.8	FXQ30K125G212GL5
305	630	1.5	32.0	24.5	13.0	27.5	\	225	675	150	0.8	FXQ30K155G222GL5
305	630	2.2	32.0	28.0	14.0	27.5	\	330	990	150	0.8	FXQ30K225G262GL5
305	630	3.3	32.0	33.0	18.0	27.5	\	495	1485	150	0.8	FXQ30K335G342GL5
305	630	4.7	32.0	37.0	22.0	27.5	10.2	705	2115	150	1.2	FXQ30K475G404GB5
305	630	4.7	42.5	32.0	19.0	37.5	10.2	470	1410	100	1.2	FXQ30K475K214KB5
305	630	6.8	42.5	44.0	24.0	37.5	10.2	680	2040	100	1.2	FXQ30K685K324KB5
305	630	10	42.5	45.0	30.0	37.5	20.3	1000	3000	100	1.2	FXQ30K106K424KD5
305	630	12	42.5	45.0	30.0	37.5	20.3	1200	3600	100	1.2	FXQ30K126K424KD5
305	630	12	57.5	45.0	30.0	52.5	20.3	1200	3600	100	1.2	FXQ30K126M164MD5
305	630	15	42.5	45.0	30.0	37.5	20.3	1500	4500	100	1.2	FXQ30K156K424KD5
305	630	15	57.5	45.0	30.0	52.5	20.3	1500	4500	100	1.2	FXQ30K156M164MD5
305	630	18	57.5	45.0	30.0	52.5	20.3	1800	5400	100	1.2	FXQ30K186M164MD5
305	630	20	57.5	45.0	30.0	52.5	20.3	2000	6000	100	1.2	FXQ30K206M164MD5

**General Technical Data**

Application	Interference suppression \ Across-the-line (Class X2)
Dielectric	Metallized Polypropylene Film
Reference Standard	IEC 60384-14 / EN 60384-14 / UL 60384-14 / AEC-Q200D
Climatic Category	40/110/56 IEC60068-1
Passive Flammability Class	B
Operating Temperature Range	-40°C ~ +110°C (85°C ~110°C, decreasing factor 1.25% per °C for Urms)
Protection	Solvent resistant plastic case UL94 V-0 Thermosetting resin sealing UL 94 V-0 compliant
Installation	Any position
Packaging	Packed in cardboard boxes with protection for the terminals
Storage Conditions	Storage time: ≤24months from the date marked on the label package Average relative humidity per year ≤70% RH≤85% for 30 days randomly distributed throughout the year Dew is absent Temperature: -40°C ~ +85°C
Storage Life	Product that passed less than 2 years from production, No need reconfirmation
RoHS Compliant	Compliant with the restricted substance requirements of Directive 2011/65/EU
Flame Retardant Grade	Flame retardant performance accords with horizontal combustion grade HB and vertical combustion grade V-0.

**Construction**

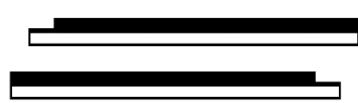
Metallized Film	OPP & Al/Zn
Metal Sprayed	Sn/Zn Alloy
Connection Electrode	Copper clad steel wire or Tinned copper wires
Case	Plastic Case (UL94V-0)
Filling	Epoxy Resin (UL94V-0)
Film Construction	<p>Mono Structure</p> 

### Electrical Characteristics

Voltage Range	250Vac ~ 305Vac
Capacitance Range	0.01 $\mu$ F to 20.0 $\mu$ F
Capacitance Tolerance	$\pm$ 10% or $\pm$ 20% at +25°C
Capacitance	Measuring Frequency at 1kHz Measuring Voltage: $1 \pm 0.2$ V
Standard Atmospheric Conditions for Static Test	<b>Ambient temperature</b> 15°C to 35°C (If there is any doubt on the results, the measurements shall be made at +20 +/- 5°C) <b>Relative humidity</b> 45% to 75% (If there is any doubt on the results, the measurements shall be made at 60% to 70%.) <b>Air pressure</b> 86 kPa to 106 kPa.
Voltage Between Terminals $U_{TT}$	DC Voltage: 1312VDC for 60 sec or 2000VDC for 2 sec, charge current must be 1A max. Withstanding (DC) voltage (cut off current 10mA), rise time 100V/S. AC Voltage: 1000VAC for 60 seconds
Voltage Between Terminals and Case $U_{TC}$	2150VAC, 60 seconds (at+20+/-2°C)
Dielectric Dissipation Factor $Tg\delta_0$	$\leq 2 \times 10^{-4}$
Dissipation Factor	0.0010 (20°C, 1KHz)
Insulation Resistance	R between leads, for $C \leq 0.33 \mu F$ at 100 V; 1 min > 15 000 M $\Omega$ RC between leads, for $C > 0.33 \mu F$ at 100 V; 1 min > 5000 M $\Omega$ * $\mu$ F
Hot-Spot	$\leq 85^\circ C$
Life Expectancy	100 000hours (UR, $\Theta_{hotspot}=85^\circ C$ )
Failure Rate	100 Fit
Max. Altitude	2000 m

**Characteristics Curve**

Maximum Current ( $I_{rms}$ ) Vs Frequency

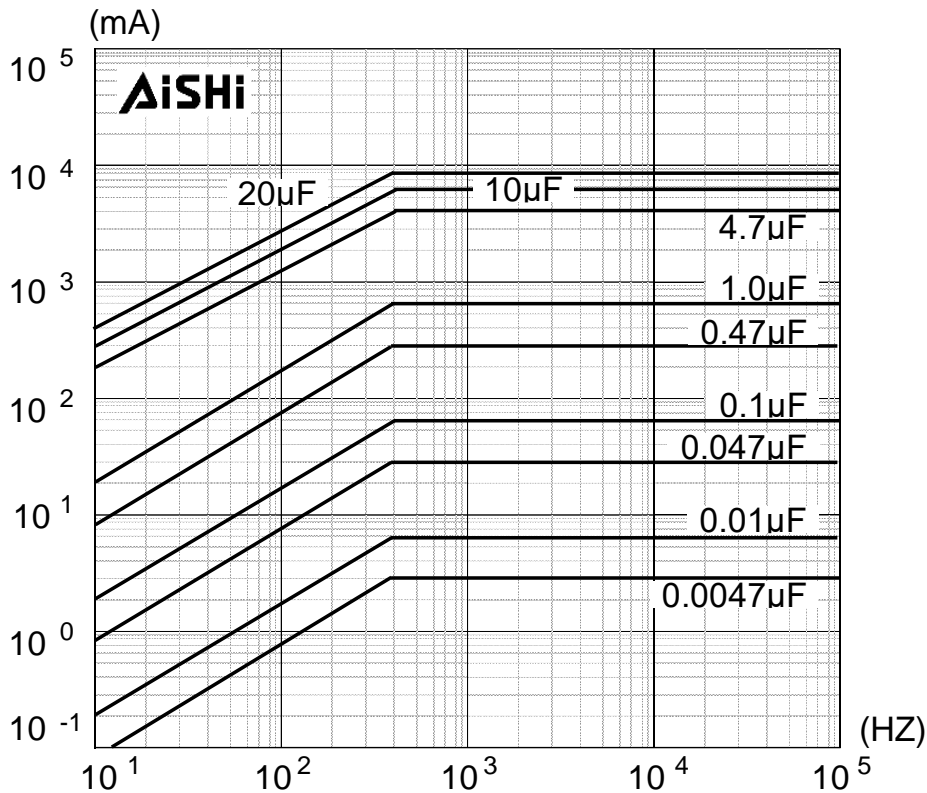

Resonant VS Capacitance

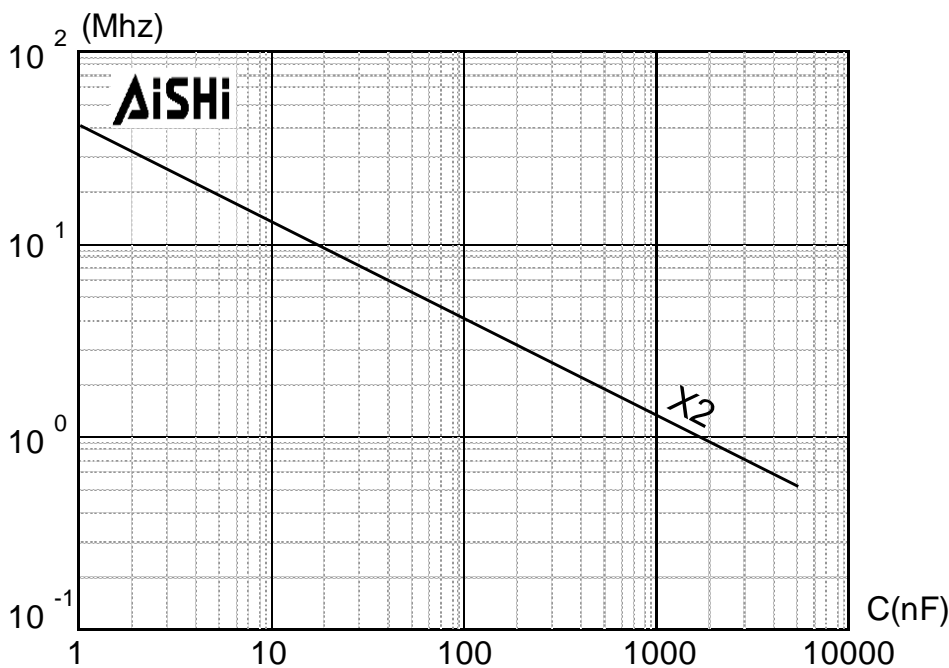

**Characteristics Curve**

Maximum Voltage ( $V_{rms}$ ) Versus Frequency

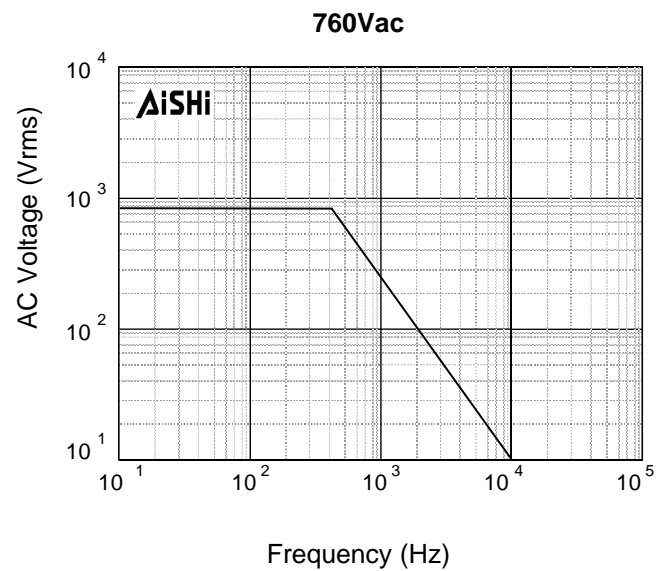
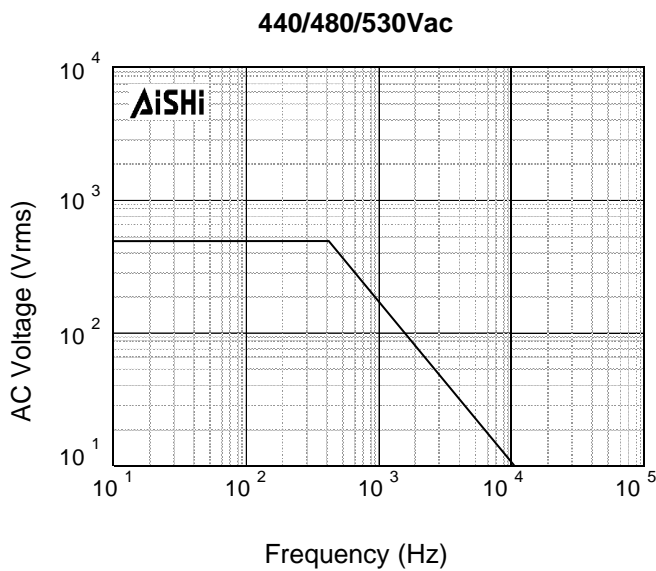
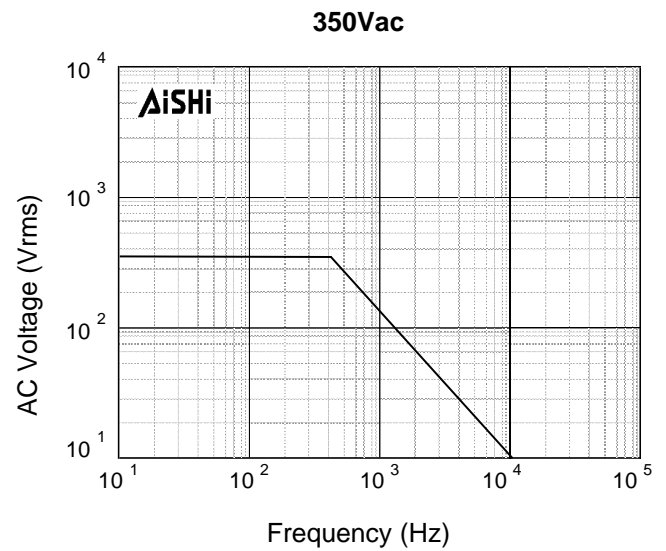
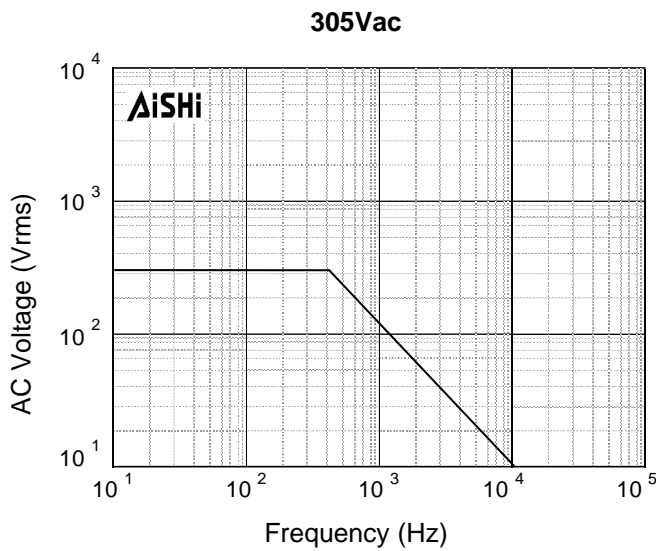



**Expected Life Curve**

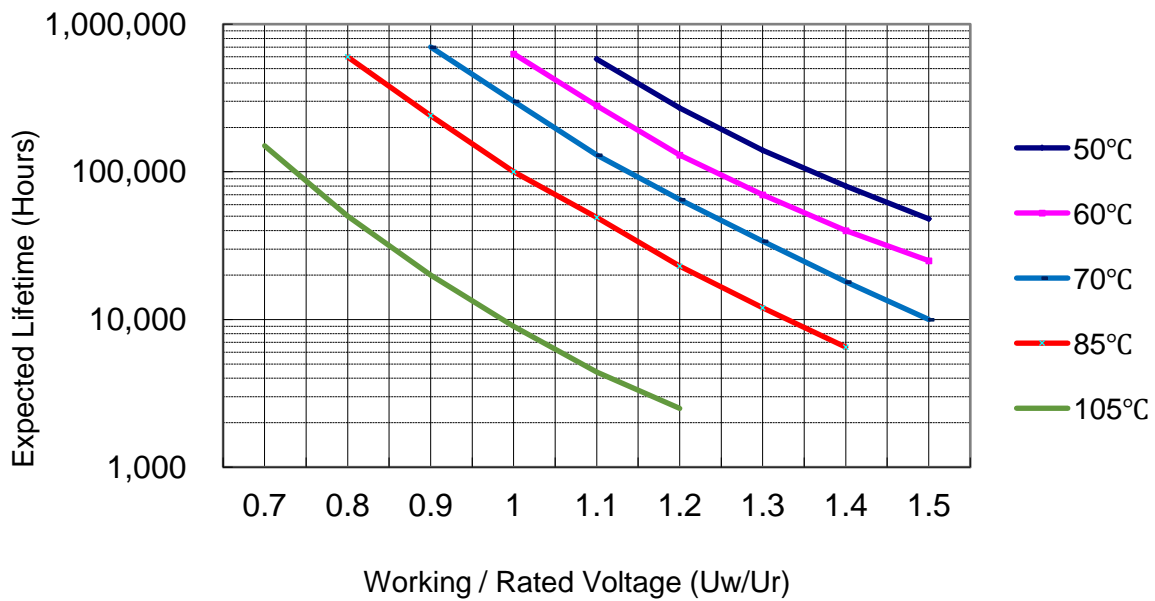

**Derating of Rated Voltage Vs Temperature**

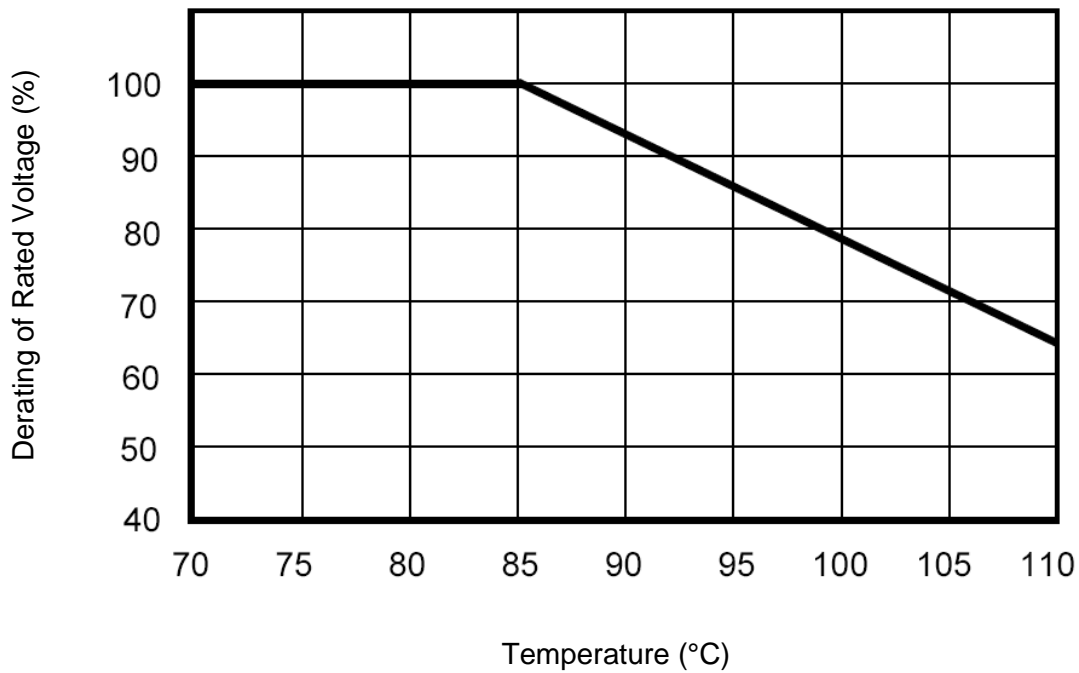

**Wave Soldering Recommendations**

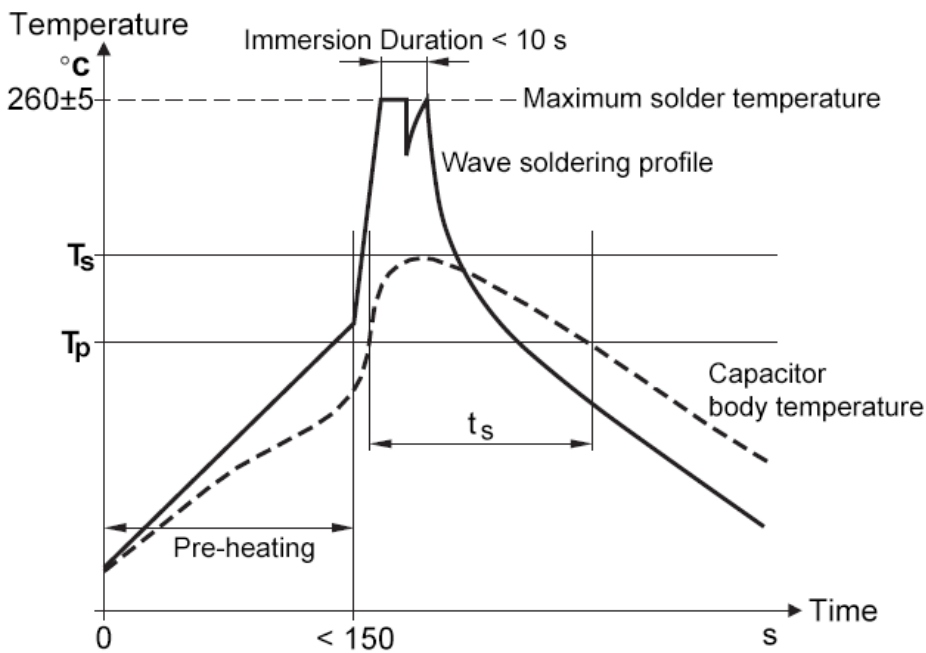

$T_s$ : Capacitor body maximum temperature at wave soldering  
 $T_p$ : Capacitor body maximum temperature at pre-heating

Polypropylene Capacitors	Polyester Capacitors
During pre-heating: $T_p \leq 110^\circ\text{C}$ During soldering: $T_s \leq 120^\circ\text{C}$ , $t_s \leq 60$	During pre-heating: $T_p \leq 130^\circ\text{C}$ During soldering: $T_s \leq 160^\circ\text{C}$ , $t_s \leq 60\text{s}$

**Packaging Information**

Inner Box Specifications (Dimensions)			
Box #	L ±3mm	W±3mm	H ±3mm
# 1	331	331	25
# 2	331	331	35
# 3	331	331	50
# 4	331	331	80
# 5	350	170	35
# 6	350	170	50
# 7	350	170	80

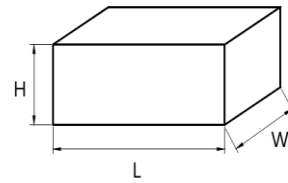

Outer Box Specifications (Dimensions)			
Box #	L ±5mm	W±5mm	H ±5mm
# 1	350	340	265
# 2	370	360	350

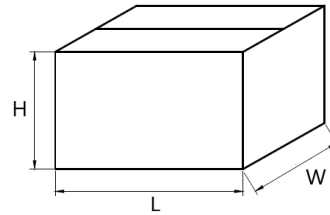

**Packaging Quantity**

P	Code	W	H	T	Long Leads	Short Leads	Ammo
10.0	C13	13.0	11.0	5.0	1200	1426	600
	C16	13.0	12.0	6.0	1200	1173	500
	C26	13.0	14.0	8.0	1200	874	370
15.0	E17	18.0	12.0	6.0	800	867	500
	E21	18.0	13.0	7.0	800	748	420
	E34	18.0	14.5	8.5	600	612	350
	E43	18.0	16.0	10.0	600	527	300
	E47	18.0	19.0	11.0	600	476	270
	E52	18.0	22.0	12.5	600	408	240
22.5	F17	26.0	16.5	7.0	600	528	252
	F20	26.0	17.0	8.5	600	432	210
	F24	26.0	19.0	10.0	400	372	180
	F26	26.0	20.0	11.0	400	336	162
	F27	26.0	22.0	12.0	400	300	150
	F29	26.0	23.0	13.0	400	276	138
	F32	26.0	24.0	14.0	400	264	126
	F36	26.0	25.0	15.0	400	240	120
27.5	G18	32.0	20.0	11.0	200	252	162
	G21	32.0	22.0	13.0	200	207	138
	G22	32.0	24.5	13.0	200	207	138
	G26	32.0	28.0	14.0	200	198	126
	G34	32.0	33.0	18.0	100	153	96
	G40	32.0	37.0	22.0	100	126	78
37.5	K21	42.5	32.0	19.0		112	
	K32	42.5	44.0	24.0		91	
	K42	42.5	45.0	30.0		70	
52.5	M16	57.5	45.0	30.0		50	

## Lead Taping Information

### Taping Style: Straight leads

Lead spacing: 10 - 15mm

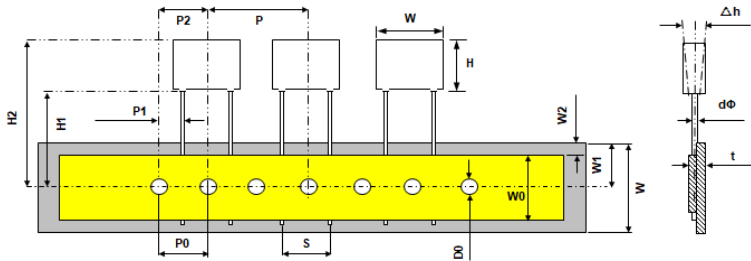

Quantity: 10pcs / line

Lead spacing: 22.5mm

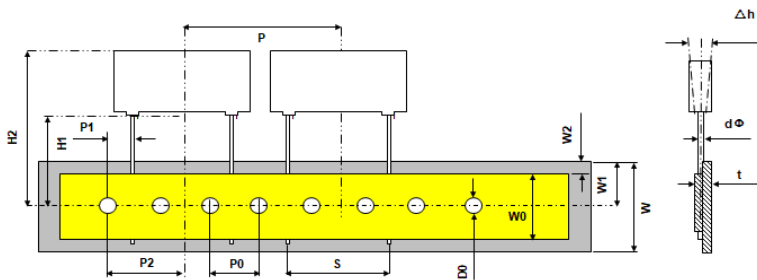

Quantity: 6pcs / line

## Taping Specification

Description	Symbol	Dimension (mm)				Tolerance
Lead Spacing	S	10.0	12.5	15.0	22.5	+0.8/-0.2
Taping Pitch	P	25.4	25.4	25.4	38.0	±1.0
Feed Hole Pitch	P0	12.7	12.7	12.7	12.7	±0.2
Centering of Lead Wire	P1	7.7	6.5	5.2	7.80	±0.7
Centering of Body	P2	12.7	12.7	12.7	19.1	±1.3
Carrier Tape Width	W	18.0	18.0	18.0	18.0	±0.5
Hold Down Tape Width	W0	9.5	9.5	9.5	9.5	minimum
Hole Position	W1	9.0	9.0	9.0	9.0	±0.5
Hold Down Tape Position	W2	3.0	3.0	3.0	3.0	maximum
Feed Hole Diameter	D0	4.0	4.0	4.0	4.0	±0.2
Height of Component From Tape Center	H1	20.0	20.0	20.0	20.0	±0.5
Top Edge of Component	H2	39.0	39.0	39.0	44.0	maximum
Lead Wire Diameter	d	0.6	0.8	0.8	0.8	±0.1
Component Alignment	Δh	0.0	0.0	0.0	0.0	±2.0
Tape Thickness	t	0.7	0.7	0.7	0.7	±0.2

## Cautions and Warnings

- Don't exceed the upper category temperature.
- For longtime storage, maximum relative humidity 80%, no dew allowed on the capacitor.
- Do not use or store capacitor in corrosive atmosphere, in the dusty environment's regular maintenance and cleaning especially of the terminals is required to avoid conductive path between terminal / or terminal and ground.
- Don't apply any mechanical stress to the capacitor terminals, and avoid any compressive, tensile or flexural stress.
- Don't move the capacitor after fixed to the PC board, and don't pick up the PC board by the fixed capacitor.
- Don't place the capacitor on a PC board whose holes pitch differs from the specified space.
- Avoid overload of the capacitors
- Do not have unlimited service life expectancy, the max service life expectancy may vary depending on the application the capacitor is used in.

## Disclaimer

All product, product specifications and data in this datasheet are subject to change without notice to improve reliability, function or design or otherwise. The customer is responsible for checking and verifying the extent to which the Information contained in this publication is applicable to an order at the time the order is placed. All Information given herein is believed to be accurate and reliable, but it is presented without guarantee, warranty, or responsibility of any kind, expressed or implied.

In individual cases, a malfunction of electronic components or failure before the end of their usual service life cannot be completely ruled out in the current state of the art, even if they are operated as specified. In customer application requiring a very high level of operational safety and especially in customer applications in which the malfunction or failure of an electronic component could endanger human life or health (e.g. in accident prevention or lifesaving systems), it must therefore be ensured by means of suitable design of the customer application or other action taken by the customer (e.g. installation of protective circuitry or redundancy) that no injury or damage is sustained by third parties in the event of malfunction or failure of an electronic component.

We continue efforts to improve our products. Therefore, the products described in this publication may change from time to time. The same is true of the corresponding product specifications. Please check therefore to what extent product descriptions and specifications contained in this publication are still applicable before or when you place an order. We also reserve the right to discontinue production and delivery of products. Consequently, we cannot guarantee that all products named in this publication will always be available.

No license, express or implied, by estoppel or otherwise, to any intellectual property rights is granted by this document or by any conduct of Aishi. Product names and markings noted herein may be trademarks of their respective owners.