

### Overview

The FX2 series is constructed of metallized polypropylene film encapsulated with self-extinguishing resin in a box of material meeting the requirement of UL94V-0.

### Applications

Interference suppression, across-the-line capacitor, EMI filter and spark-killer in class X2 applications. Suitable for use in situations where failure of the capacitor would not lead to danger of electric shock.

### Features

- High stability of capacitance
- High temperature (110°C)
- Self-healing property
- Over voltage stress withstanding
- Flame-retardant plastic case and resin

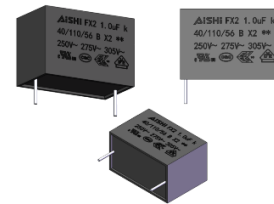

### Approvals

Marking	Standard	File Number
	UL 60384-14 and, CAN/CSA-E60384-14	E500538
	EN/IEC 60384-14	40051583
	IEC 60384-14, GB/T6346.14-2015	CQC20001245437

### Marking

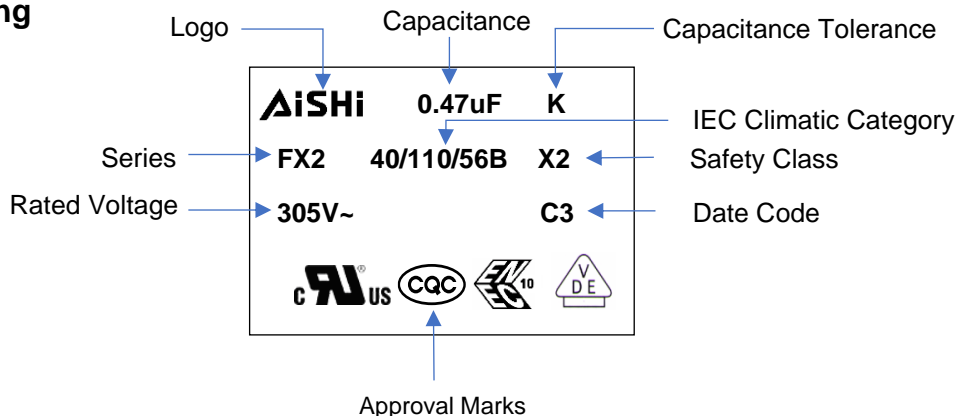

### Manufacturing Date Code

Year	Code	Month	Code
2018	A	Jan	1
2019	B	Feb	2
2020	C	Mar	3
2021	D	Apr	4
2022	E	May	5
2023	F	Jun	6

Year	Code	Month	Code
2024	G	Jul	7
2025	H	Aug	8
2026	J	Sep	9
2027	K	Oct	A
2028	L	Nov	N
2029	M	Dec	D

### Part Number System

F	X2	30	K	474	E43	2EL	5
Capacitor Type	Series	Voltage (VAC)	Tolerance	Capacitance (pF)	Size Code	Terminal Code	Lead Length Code
F = Film	Class X2, Metallized PP Film	305	K = ±10% M = ±20%	First two digits = significant figures. Third digit = Number of zeros.	Refer to Size Code Table	Refer to Terminal Code Table	Refer to Lead Length Table

### Terminal Code

Digit One (Lead/Terminal Type)		Digit Two (Lead Space)		Digit Three (Lead Ipsilateral)	
2 leads for long	L	10.0mm	C	5.1mm	A
2 leads for straight cut	2	12.5mm	D	7.5mm	C
2 leads for forming cut	E	15.0mm	E	10.2mm	B
4 leads for straight cut	4	22.5mm	F	12.7mm	G
Taping	T	27.5mm	G	20.3mm	D
Taping Straight	V	37.5mm	K	N/A	L
		57.5mm	M		
		N/A	N		

### Lead Length Code

Lead Length	
20mm min	L
35mm min	B
3.2mm	1
3.5mm	2
3.0mm	3
4.0mm	4
5.0mm	5
7.0mm	7
Taping	T
N/A	N

**Dimension (mm)**

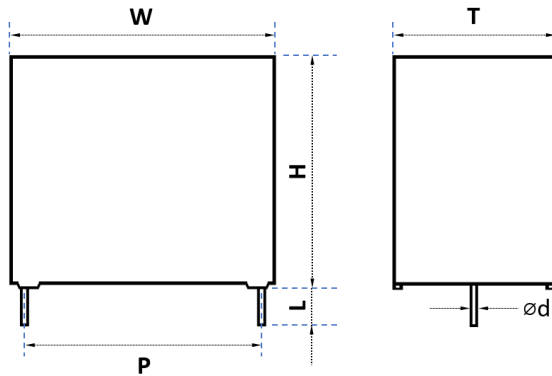

**2 pins**

**Size Code Table (mm)**

Size Code	Dimension						Pitch		Lead Wire	
	W	Tolerance	H	Tolerance	T	Tolerance	P	Tolerance	Ød	Tolerance
C13	13.0	0.5	11.0	0.5	5.0	0.5	10.0	0.5	0.6	0.05
C16	13.0	0.5	12.0	0.5	6.0	0.5	10.0	0.5	0.6	0.05
C24	13.0	0.5	13.0	0.5	7.0	0.5	10.0	0.5	0.6	0.05
C26	13.0	0.5	14.0	0.5	8.0	0.5	10.0	0.5	0.6	0.05
C27	13.0	0.5	16.0	0.5	8.0	0.5	10.0	0.5	0.6	0.05
C30	13.0	0.5	16.0	0.5	9.0	0.5	10.0	0.5	0.6	0.05
D13	15.0	0.5	12.5	0.5	7.0	0.5	12.5	0.5	0.6	0.05
D16	15.0	0.5	14.0	0.5	8.5	0.5	12.5	0.5	0.6	0.05
D20	15.0	0.5	16.0	0.5	10.0	0.5	12.5	0.5	0.6	0.05
E14	18.0	0.5	11.0	0.5	5.0	0.5	15.0	0.5	0.6	0.05
E17	18.0	0.5	12.0	0.5	6.0	0.5	15.0	0.5	0.6	0.05
E29	18.0	0.5	13.5	0.5	7.5	0.5	15.0	0.5	0.8	0.05
E34	18.0	0.5	14.5	0.5	8.5	0.5	15.0	0.5	0.8	0.05
E43	18.0	0.5	16.0	0.5	10.0	0.5	15.0	0.5	0.8	0.05
E47	18.0	0.5	19.0	0.5	11.0	0.5	15.0	0.5	0.8	0.05
E45	18.0	0.5	18.0	0.5	10.0	0.5	15.0	0.5	0.8	0.05
E52	18.0	0.5	22.0	0.5	12.5	0.5	15.0	0.5	0.8	0.05
F17	26.0	0.5	16.5	0.5	7.0	0.5	22.5	0.5	0.8	0.05
F20	26.0	0.5	17.0	0.5	8.5	0.5	22.5	0.5	0.8	0.05
F24	26.0	0.5	19.0	0.5	10.0	0.5	22.5	0.5	0.8	0.05
F26	26.0	0.5	20.0	0.5	11.0	0.5	22.5	0.5	0.8	0.05
F29	26.0	0.5	23.0	0.5	13.0	0.5	22.5	0.5	0.8	0.05
G15	32.0	0.8	18.0	0.8	9.0	0.8	27.5	0.5	0.8	0.05
G18	32.0	0.8	20.0	0.8	11.0	0.8	27.5	0.5	0.8	0.05
G21	32.0	0.8	22.0	0.8	13.0	0.8	27.5	0.5	0.8	0.05
G22	32.0	0.8	24.5	0.8	13.0	0.8	27.5	0.5	0.8	0.05
G26	32.0	0.8	28.0	0.8	14.0	0.8	27.5	0.5	0.8	0.05
G34	32.0	0.8	33.0	0.8	18.0	0.8	27.5	0.5	0.8	0.05
G40	32.0	0.8	37.0	0.8	22.0	0.8	27.5	0.5	0.8	0.05
K21	42.5	0.8	32.0	0.8	19.0	0.8	37.5	0.5	1.0	0.05
K24	42.5	0.8	40.0	0.8	20.0	0.8	37.5	0.5	1.0	0.05
K32	42.5	0.8	44.0	0.8	24.0	0.8	37.5	0.5	1.0	0.05
K42	42.5	0.8	45.0	0.8	30.0	0.8	37.5	0.5	1.0	0.05
M16	57.5	1.0	45.0	1.0	30.0	1.0	52.5	0.5	1.2	0.05

**Rating and Part Number**

Vac	Vdc	Cap Value μF	Dimensions				Peak Current A	Surge Current A	dv/dt V/us	Lead Wire mm	Part Number
			W mm	H mm	T mm	P mm					
305	630	0.01	10.0	12.0	6.0	7.5	6.0	18.0	600	0.6	FX230K103B162BL5
305	630	0.022	10.0	12.0	6.0	7.5	13.2	39.6	600	0.6	FX230K223B162BL5
305	630	0.03	10.0	12.0	6.0	7.5	19.8	59.4	600	0.6	FX230K333B162BL5
305	630	0.047	10.0	12.0	6.0	7.5	28.2	84.6	600	0.6	FX230K473B162BL5
305	630	0.07	10.0	13.0	7.0	7.5	40.8	122.4	600	0.6	FX230K683B172BL5
305	630	0.100	10.0	14.0	8.0	7.5	60.0	180.0	600	0.6	FX230K104B182BL5
305	630	0.01	13.0	11.0	5.0	10.0	5.0	15.0	500	0.6	FX230K103C132CL5
305	630	0.022	13.0	11.0	5.0	10.0	11.0	33.0	500	0.6	FX230K223C132CL5
305	630	0.03	13.0	11.0	5.0	10.0	16.5	49.5	500	0.6	FX230K333C132CL5
305	630	0.047	13.0	11.0	5.0	10.0	23.5	70.5	500	0.6	FX230K473C132CL5
305	630	0.07	13.0	11.0	5.0	10.0	34.0	102.0	500	0.6	FX230K683C132CL5
305	630	0.082	13.0	11.0	5.0	10.0	41.0	123.0	500	0.6	FX230K823C132CL5
305	630	0.08	13.0	12.0	6.0	10.0	41.0	123.0	500	0.6	FX230K823C162CL5
305	630	0.100	13.0	12.0	6.0	10.0	50.0	150.0	500	0.6	FX230K104C162CL5
305	630	0.15	13.0	13.0	7.0	10.0	75.0	225.0	500	0.6	FX230K154C242CL5
305	630	0.150	13.0	14.0	8.0	10.0	75.0	225.0	500	0.6	FX230K154C262CL5
305	630	0.22	13.0	14.0	8.0	10.0	110.0	330.0	500	0.6	FX230K224C262CL5
305	630	0.270	13.0	16.0	8.0	10.0	135.0	405.0	500	0.6	FX230K274C272CL5
305	630	0.33	13.0	16.0	9.0	10.0	165.0	495.0	500	0.6	FX230K334C302CL5
305	630	0.150	15.0	12.5	7.0	12.5	75.0	225.0	500	0.6	FX230K154D132DL5
305	630	0.22	15.0	12.5	7.0	12.5	110.0	330.0	500	0.6	FX230K224D132DL5
305	630	0.330	15.0	14.0	8.5	12.5	165.0	495.0	500	0.6	FX230K334D162DL5
305	630	0.47	15.0	16.0	10.0	12.5	235.0	705.0	500	0.6	FX230K474D202DL5
305	630	0.047	18.0	11.0	5.0	15.0	18.8	56.4	400	0.6	FX230K473E142EL5
305	630	0.07	18.0	11.0	5.0	15.0	27.2	81.6	400	0.6	FX230K683E142EL5
305	630	0.082	18.0	11.0	5.0	15.0	32.8	98.4	400	0.6	FX230K823E142EL5
305	630	0.10	18.0	11.0	5.0	15.0	40.0	120.0	400	0.6	FX230K104E142EL5
305	630	0.100	18.0	12.0	6.0	15.0	40.0	120.0	400	0.6	FX230K104E172EL5
305	630	0.15	18.0	12.0	6.0	15.0	60.0	180.0	400	0.6	FX230K154E172EL5
305	630	0.220	18.0	12.0	6.0	15.0	88.0	264.0	400	0.6	FX230K224E172EL5
305	630	0.22	18.0	13.5	7.5	15.0	88.0	264.0	400	0.8	FX230K224E292EL5
305	630	0.270	18.0	13.5	7.5	15.0	108.0	324.0	400	0.8	FX230K274E292EL5
305	630	0.27	18.0	14.5	8.5	15.0	108.0	324.0	400	0.8	FX230K274E342EL5
305	630	0.330	18.0	14.5	8.5	15.0	132.0	396.0	400	0.8	FX230K334E342EL5
305	630	0.33	18.0	16.0	10.0	15.0	132.0	396.0	400	0.8	FX230K334E432EL5
305	630	0.470	18.0	16.0	10.0	15.0	188.0	564.0	400	0.8	FX230K474E432EL5
305	630	0.47	18.0	19.0	11.0	15.0	188.0	564.0	400	0.8	FX230K474E472EL5
305	630	0.560	18.0	18.0	10.0	15.0	224.0	672.0	400	0.8	FX230K564E452EL5
305	630	0.68	18.0	19.0	11.0	15.0	272.0	816.0	400	0.8	FX230K684E472EL5
305	630	0.820	18.0	19.0	11.0	15.0	328.0	984.0	400	0.8	FX230K824E472EL5
305	630	1.00	18.0	22.0	12.5	15.0	400.0	1200.0	400	0.8	FX230K105E522EL5
305	630	0.220	26.0	16.5	7.0	22.5	44.0	132.0	200	0.8	FX230K224F172FL5
305	630	0.27	26.0	16.5	7.0	22.5	54.0	162.0	200	0.8	FX230K274F172FL5
305	630	0.330	26.0	17.0	8.5	22.5	66.0	198.0	200	0.8	FX230K334F202FL5
305	630	0.47	26.0	17.0	8.5	22.5	94.0	282.0	200	0.8	FX230K474F202FL5
305	630	0.470	26.0	19.0	10.0	22.5	94.0	282.0	200	0.8	FX230K474F242FL5
305	630	0.56	26.0	17.0	8.5	22.5	112.0	336.0	200	0.8	FX230K564F202FL5
305	630	0.560	26.0	19.0	10.0	22.5	112.0	336.0	200	0.8	FX230K564F242FL5

**Rating and Part Number**

Vac	Vdc	Cap Value μF	Dimensions				Peak Current A	Surge Current A	dv/dt V/us	Lead Wire mm	Part Number
			W mm	H mm	T mm	P mm					
305	630	0.68	26.0	17.0	8.5	22.5	136.0	408.0	200	0.8	FX230K684F202FL5
305	630	0.680	26.0	19.0	10.0	22.5	136.0	408.0	200	0.8	FX230K684F242FL5
305	630	0.82	26.0	19.0	10.0	22.5	164.0	492.0	200	0.8	FX230K824F242FL5
305	630	1.000	26.0	19.0	10.0	22.5	200.0	600.0	200	0.8	FX230K105F242FL5
305	630	1.00	26.0	20.0	11.0	22.5	200.0	600.0	200	0.8	FX230K105F262FL5
305	630	1.200	26.0	23.0	13.0	22.5	240.0	720.0	200	0.8	FX230K125F292FL5
305	630	1.5	26.0	23.0	13.0	22.5	300.0	900.0	200	0.8	FX230K155F292FL5
305	630	0.68	32.0	18.0	9.0	27.5	102.0	306.0	150	0.8	FX230K684G152GL5
305	630	0.82	32.0	18.0	9.0	27.5	123.0	369.0	150	0.8	FX230K824G152GL5
305	630	1	32.0	20.0	11.0	27.5	150.0	450.0	150	0.8	FX230K105G182GL5
305	630	1.2	32.0	22.0	13.0	27.5	180.0	540.0	150	0.8	FX230K125G212GL5
305	630	2	32.0	24.5	13.0	27.5	225.0	675.0	150	0.8	FX230K155G222GL5
305	630	2.2	32.0	28.0	14.0	27.5	330.0	990.0	150	0.8	FX230K225G262GL5
305	630	3	32.0	33.0	18.0	27.5	495.0	1485.0	150	0.8	FX230K335G342GL5
305	630	4.7	32.0	33.0	18.0	27.5	705.0	2115.0	150	0.8	FX230K475G342GL5
305	630	4.7	32.0	37.0	22.0	27.5	705.0	2115.0	150	0.8	FX230K475G402GL5
305	630	4.7	42.5	32.0	19.0	37.5	470.0	1410.0	100	1.0	FX230K475K212KL5
305	630	6.8	42.5	40.0	20.0	37.5	680.0	2040.0	100	1.0	FX230K685K242KL5
305	630	6.8	42.5	44.0	24.0	37.5	680.0	2040.0	100	1.0	FX230K685K322KL5
305	630	10	42.5	45.0	30.0	37.5	1000.0	3000.0	100	1.0	FX230K106K422KL5
305	630	12	42.5	45.0	30.0	37.5	1200.0	3600.0	100	1.0	FX230K126K422KL5
305	630	15	42.5	45.0	30.0	37.5	1500.0	4500.0	100	1.0	FX230K156K422KL5
305	630	18	42.5	45.0	30.0	37.5	1440.0	4320.0	80	1.0	FX230K186K422KL5
305	630	20	42.5	45.0	30.0	37.5	1600.0	4800.0	80	1.0	FX230K206K422KL5
305	630	12	57.5	45.0	30.0	52.5	960.0	2880.0	80	1.2	FX230K126M162ML5
305	630	15	57.5	45.0	30.0	52.5	1200.0	3600.0	80	1.2	FX230K156M162ML5
305	630	18	57.5	45.0	30.0	52.5	1440.0	4320.0	80	1.2	FX230K186M162ML5
305	630	20	57.5	45.0	30.0	52.5	1600.0	4800.0	80	1.2	FX230K206M162ML5

**General Technical Data**

Application	Interference suppression \ Across-the-line (Class X2)
Dielectric	Metallized Polypropylene Film
Reference Standard	IEC 60384-14; UL 60384-14; GB/T 6346.14-2015
Climatic Category	40/110/56 IEC60068-1
Passive Flammability Class	B
Operating Temperature Range	-40°C ~ +110°C (85°C ~110°C, decreasing factor 1.25% per °C for Urms)
Protection	Solvent resistant plastic case UL94 V-0 Thermosetting resin sealing UL 94 V-0 compliant
Installation	Any position
Packaging	Packed in cardboard boxes with protection for the terminals
Storage Conditions	Storage time: ≤24months from the date marked on the label package Average relative humidity per year ≤70% RH≤85% for 30 days randomly distributed throughout the year Dew is absent Temperature: -40°C ~ +85°C
RoHS Compliant	Compliant with the restricted substance requirements of Directive 2011/65/EU
Flame Retardant Grade	Flame retardant performance accords with horizontal combustion grade HB and vertical combustion grade V-0.

**Construction**

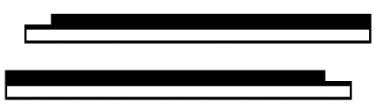
Metallized Film	OPP & Al/Zn
Metal Sprayed	Sn/Zn Alloy
Connection Electrode	Copper clad steel wire or Tinned copper wires
Plastic Case	Plastic Case (UL94V-0)
Filling	Epoxy Resin (UL94V-0)
Film Construction	<p>Mono Structure</p> 

### Electrical Characteristics

Voltage Range	250Vac ~ 305Vac
Capacitance Range	0.01 $\mu$ F to 20.0 $\mu$ F
Capacitance Tolerance	$\pm$ 10% or $\pm$ 20% at +25°C
Capacitance	Measuring Frequency at 1kHz Measuring Voltage: $1\pm 0.2$ V
Standard Atmospheric Conditions for Static Test	<b>Ambient temperature</b> 15°C to 35°C (If there is any doubt on the results, the measurements shall be made at +20 +/- 5°C) <b>Relative humidity</b> 45% to 75% (If there is any doubt on the results, the measurements shall be made at 60% to 70 %.) <b>Air pressure</b> 86 kPa to 106 kPa.
Voltage Between Terminals $U_{TT}$	DC Voltage: 1312VDC for 60 seconds or 2000VDC for 2 seconds, charge current must be 1A max. Withstanding (DC) voltage (cut off current 10mA), rise time 100V/S. AC Voltage: 1000VAC for 60 seconds
Voltage Between Terminals and Case $U_{TC}$	2150VAC, 60s (at+20+/-2°C)
Dielectric Dissipation Factor $Tg\delta 0$	$\leq 2 \times 10^{-4}$
Dissipation Factor	0.0010 (20°C, 1KHz)
Insulation Resistance	R between leads, for $C \leq 0.33 \mu F$ at 100 V; 1 min > 15 000 M $\Omega$ RC between leads, for $C > 0.33 \mu F$ at 100 V; 1 min > 5000 M $\Omega$ * $\mu$ F
Hot-Spot	$\leq 85^\circ C$
Life Expectancy	100 000hours (UR, $\Theta_{hotspot}=85^\circ C$ )
Failure Rate	100 Fit
Max. Altitude	2000 m

**Characteristics Curve**

Maximum Current ( $I_{rms}$ ) Vs Frequency

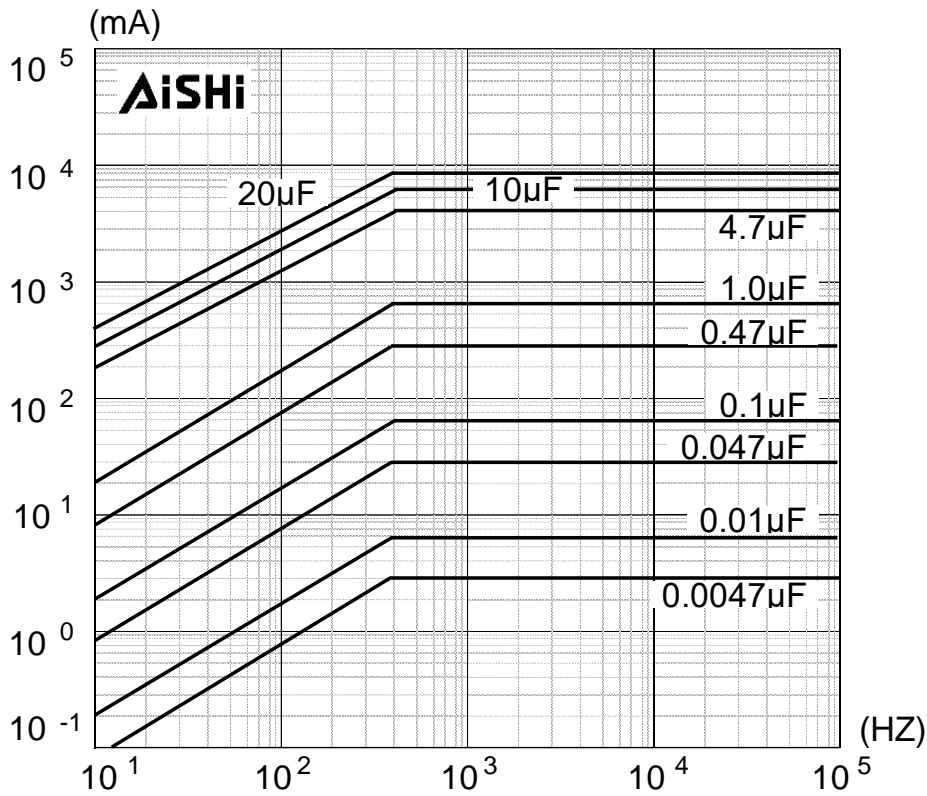

Resonant VS Capacitance

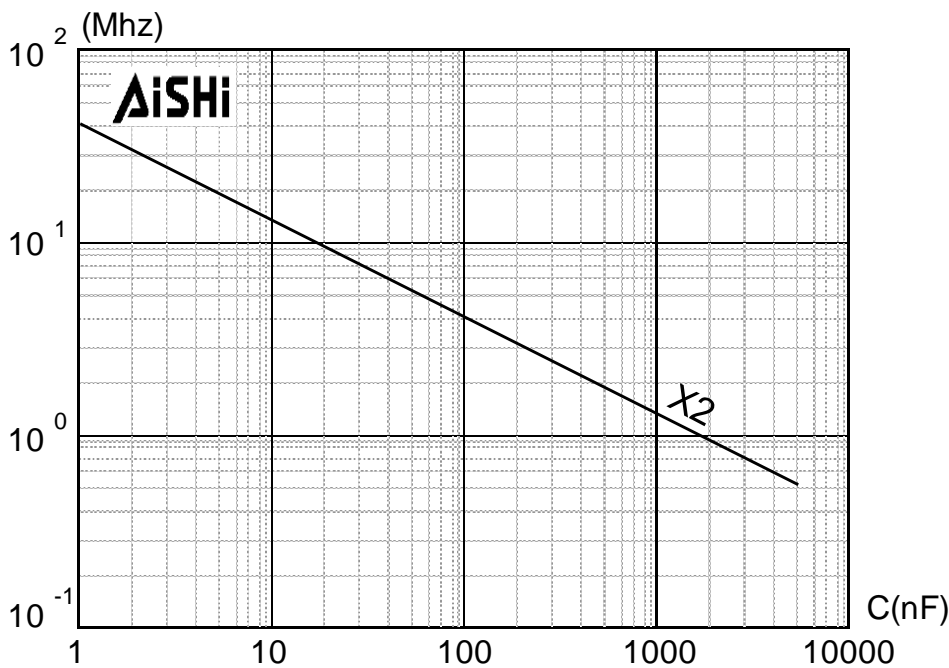



### Characteristics Curve

Maximum Voltage ( $V_{rms}$ ) Versus Frequency

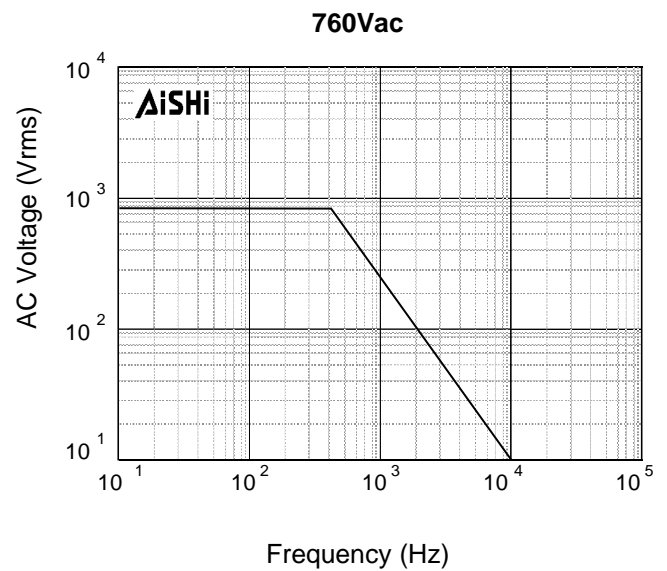
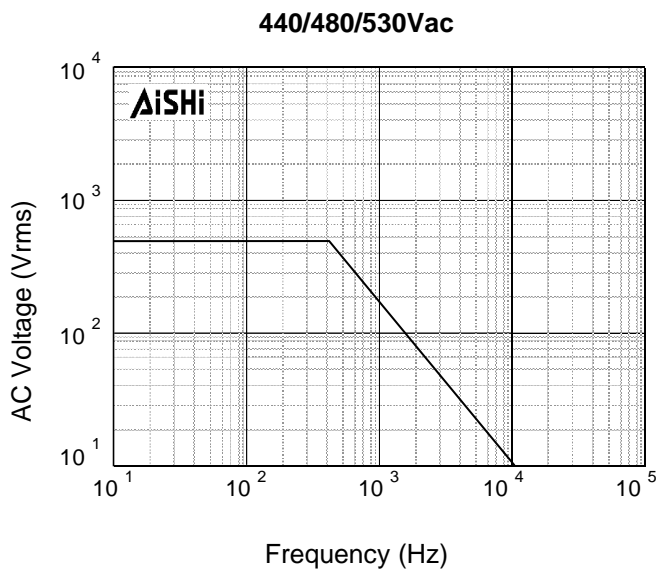
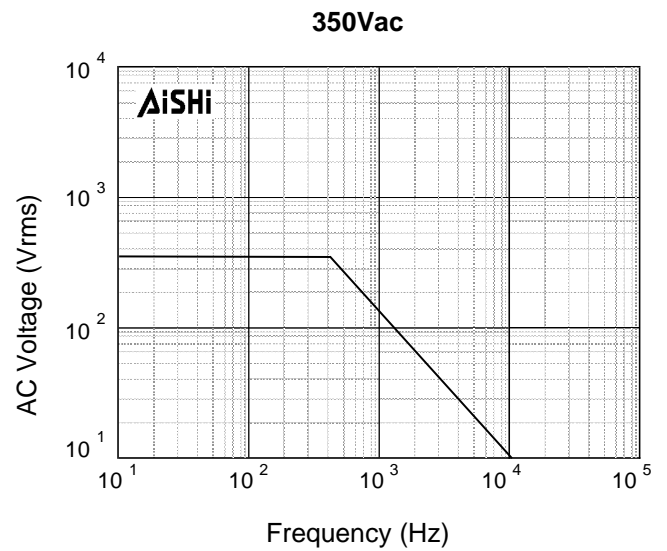
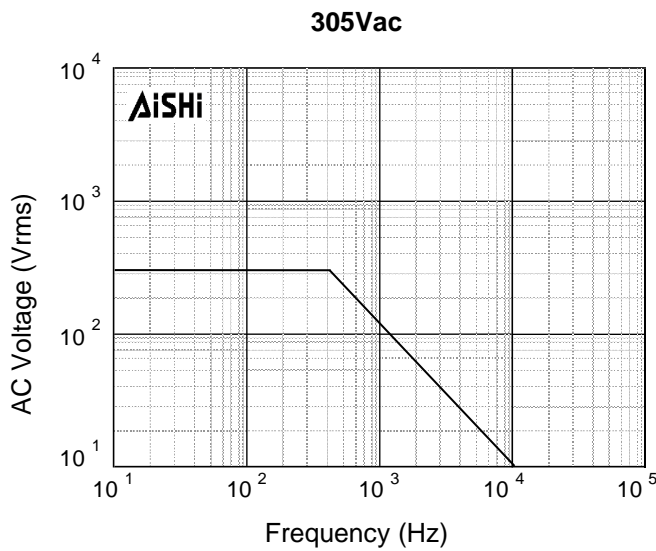

**Expected Life Curve**

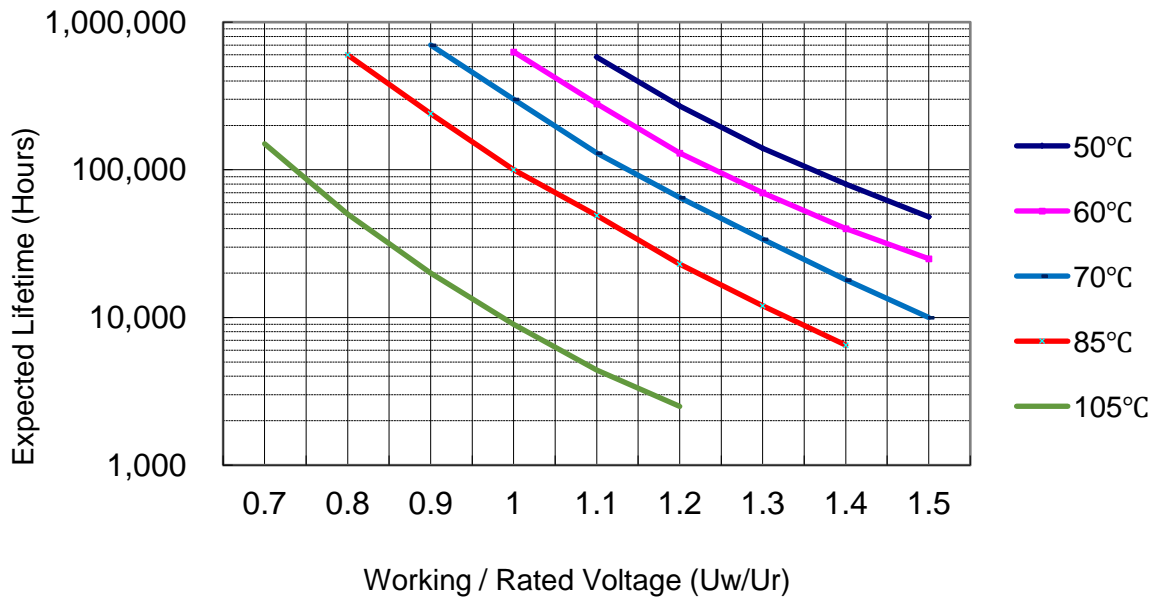

**Derating of Rated Voltage Vs Temperature**

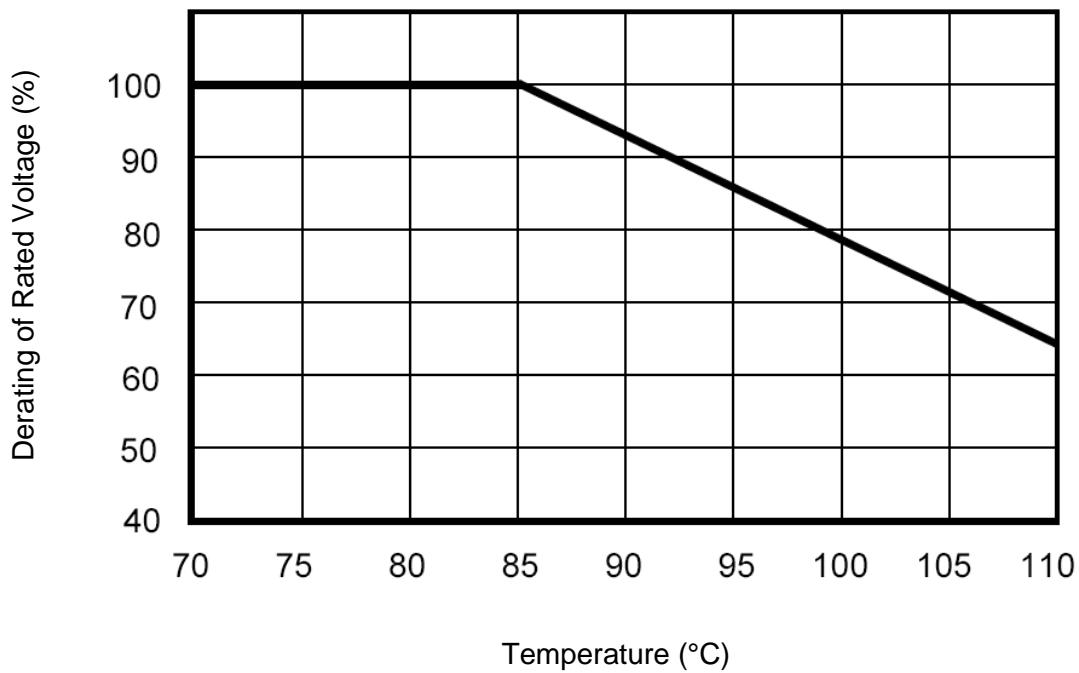

**Wave Soldering Recommendations**

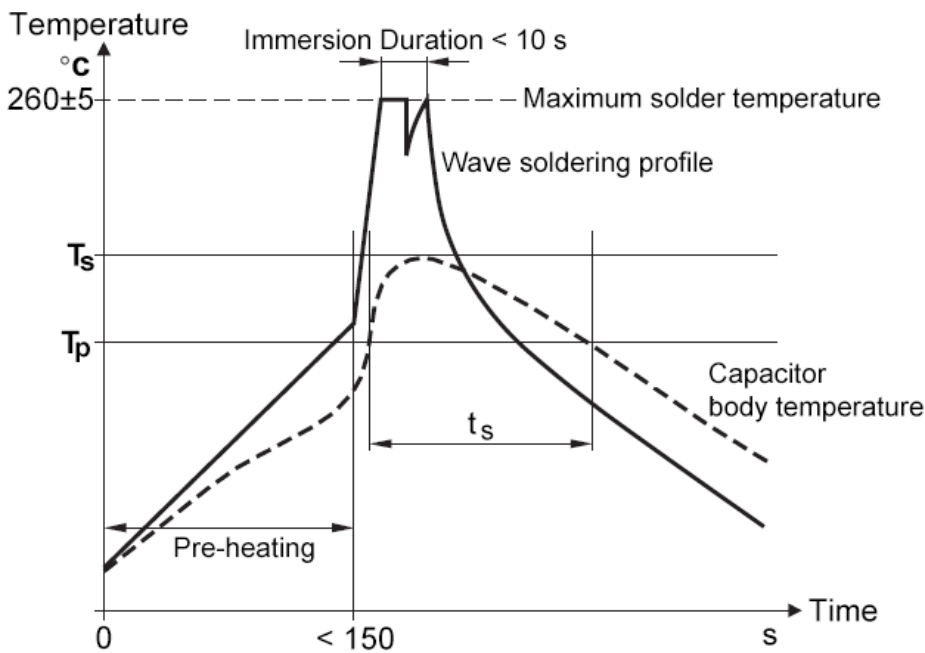

$T_s$ : Capacitor body maximum temperature at wave soldering  
 $T_p$ : Capacitor body maximum temperature at pre-heating

Polypropylene Capacitors	Polyester Capacitors
During pre-heating: $T_p \leq 110^\circ\text{C}$ During soldering: $T_s \leq 120^\circ\text{C}$ , $t_s \leq 60$	During pre-heating: $T_p \leq 130^\circ\text{C}$ During soldering: $T_s \leq 160^\circ\text{C}$ , $t_s \leq 60\text{s}$

**Packaging Information**

Inner Box Specifications (Dimensions)			
Box #	L ±3mm	W±3mm	H ±3mm
# 1	331	331	25
# 2	331	331	35
# 3	331	331	50
# 4	331	331	80
# 5	350	170	35
# 6	350	170	50
# 7	350	170	80

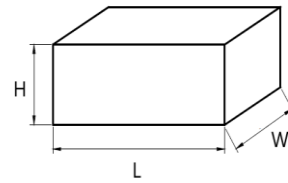

Outer Box Specifications (Dimensions)			
Box #	L ±5mm	W±5mm	H ±5mm
# 1	350	340	265
# 2	370	360	350

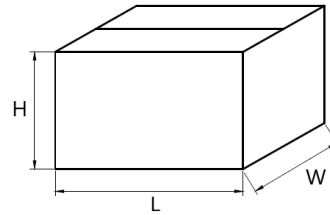

**Packaging Quantity**

P	Code	W	H	T	Long Leads	Short Leads	Ammo
10.0	C13	13.0	11.0	5.0	1200	1426	600
	C16	13.0	12.0	6.0	1200	1173	500
	C26	13.0	14.0	8.0	1200	874	370
15.0	E17	18.0	12.0	6.0	800	867	500
	E21	18.0	13.0	7.0	800	748	420
	E34	18.0	14.5	8.5	600	612	350
	E43	18.0	16.0	10.0	600	527	300
	E47	18.0	19.0	11.0	600	476	270
	E52	18.0	22.0	12.5	600	408	240
22.5	F17	26.0	16.5	7.0	600	528	252
	F20	26.0	17.0	8.5	600	432	210
	F24	26.0	19.0	10.0	400	372	180
	F26	26.0	20.0	11.0	400	336	162
	F27	26.0	22.0	12.0	400	300	150
	F29	26.0	23.0	13.0	400	276	138
	F32	26.0	24.0	14.0	400	264	126
	F36	26.0	25.0	15.0	400	240	120
27.5	G18	32.0	20.0	11.0	200	252	162
	G21	32.0	22.0	13.0	200	207	138
	G22	32.0	24.5	13.0	200	207	138
	G26	32.0	28.0	14.0	200	198	126
	G34	32.0	33.0	18.0	100	153	96
	G40	32.0	37.0	22.0	100	126	78
37.5	K21	42.5	32.0	19.0		112	
	K32	42.5	44.0	24.0		91	
	K42	42.5	45.0	30.0		70	
52.5	M16	57.5	45.0	30.0		50	

## Lead Taping Information

### Taping Style: Straight leads

Lead spacing: 10 - 15mm

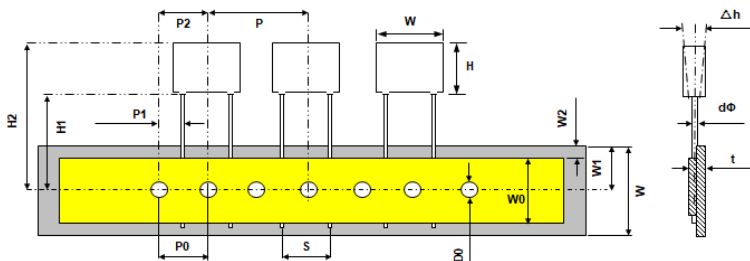

Quantity: 10pcs / line

Lead spacing: 22.5mm

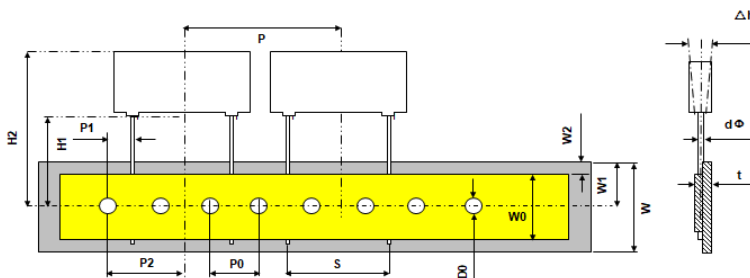

Quantity: 6pcs / line

## Taping Specification

Description	Symbol	Dimension (mm)				Tolerance
Lead Spacing	S	10.0	12.5	15.0	22.5	+0.8/-0.2
Taping Pitch	P	25.4	25.4	25.4	38.0	±1.0
Feed Hole Pitch	P0	12.7	12.7	12.7	12.7	±0.2
Centering of Lead Wire	P1	7.7	6.5	5.2	7.80	±0.7
Centering of Body	P2	12.7	12.7	12.7	19.1	±1.3
Carrier Tape Width	W	18.0	18.0	18.0	18.0	±0.5
Hold Down Tape Width	W0	9.5	9.5	9.5	9.5	minimum
Hole Position	W1	9.0	9.0	9.0	9.0	±0.5
Hold Down Tape Position	W2	3.0	3.0	3.0	3.0	maximum
Feed Hole Diameter	D0	4.0	4.0	4.0	4.0	±0.2
Height of Component From Tape Center	H1	20.0	20.0	20.0	20.0	±0.5
Top Edge of Component	H2	39.0	39.0	39.0	44.0	maximum
Lead Wire Diameter	d	0.6	0.8	0.8	0.8	±0.1
Component Alignment	Δh	0.0	0.0	0.0	0.0	±2.0
Tape Thickness	t	0.7	0.7	0.7	0.7	±0.2

## Cautions and Warnings

- Don't exceed the upper category temperature.
- For longtime storage, maximum relative humidity 80%, no dew allowed on the capacitor.
- Do not use or store capacitor in corrosive atmosphere, in the dusty environment's regular maintenance and cleaning especially of the terminals is required to avoid conductive path between terminal / or terminal and ground.
- Don't apply any mechanical stress to the capacitor terminals, and avoid any compressive, tensile or flexural stress.
- Don't move the capacitor after fixed to the PC board, and don't pick up the PC board by the fixed capacitor.
- Don't place the capacitor on a PC board whose holes pitch differs from the specified space.
- Avoid overload of the capacitors
- Do not have unlimited service life expectancy, the max service life expectancy may vary depending on the application the capacitor is used in.

## Disclaimer

All product, product specifications and data in this datasheet are subject to change without notice to improve reliability, function or design or otherwise. The customer is responsible for checking and verifying the extent to which the Information contained in this publication is applicable to an order at the time the order is placed. All Information given herein is believed to be accurate and reliable, but it is presented without guarantee, warranty, or responsibility of any kind, expressed or implied.

In individual cases, a malfunction of electronic components or failure before the end of their usual service life cannot be completely ruled out in the current state of the art, even if they are operated as specified. In customer application requiring a very high level of operational safety and especially in customer applications in which the malfunction or failure of an electronic component could endanger human life or health (e.g. in accident prevention or lifesaving systems), it must therefore be ensured by means of suitable design of the customer application or other action taken by the customer (e.g. installation of protective circuitry or redundancy) that no injury or damage is sustained by third parties in the event of malfunction or failure of an electronic component.

We continue efforts to improve our products. Therefore, the products described in this publication may change from time to time. The same is true of the corresponding product specifications. Please check therefore to what extent product descriptions and specifications contained in this publication are still applicable before or when you place an order. We also reserve the right to discontinue production and delivery of products. Consequently, we cannot guarantee that all products named in this publication will always be available.

No license, express or implied, by estoppel or otherwise, to any intellectual property rights is granted by this document or by any conduct of Aishi. Product names and markings noted herein may be trademarks of their respective owners.